

SECTION 2

OUR ANCESTORS

◆ **Introduction**

Location

“In a Nutshell”

**Donald & Helen’s Brothers & Sisters
Extended Family Relationships**

◆ **Gunn Ancestors**

Introduction

Charles Gunn & Margaret Cormack

Donald Gunn & Margaret Keith

Peter Gunn & Margaret Manson

Gavin Gunn & Janet Steven

Peter Gunn & Alexandrina Robertson

◆ **Baikie Ancestors**

Introduction

George Baikie & Mary Dunnet

Walter Baikie & Katherine Dunnett

George Baikie & Margaret Sutherland

Benjamin Baikie & Helen Barneston

James Baikie & Catherine Calder

ANCESTORS - INTRODUCTION - Location

THE PARISHES OF CAITHNESS

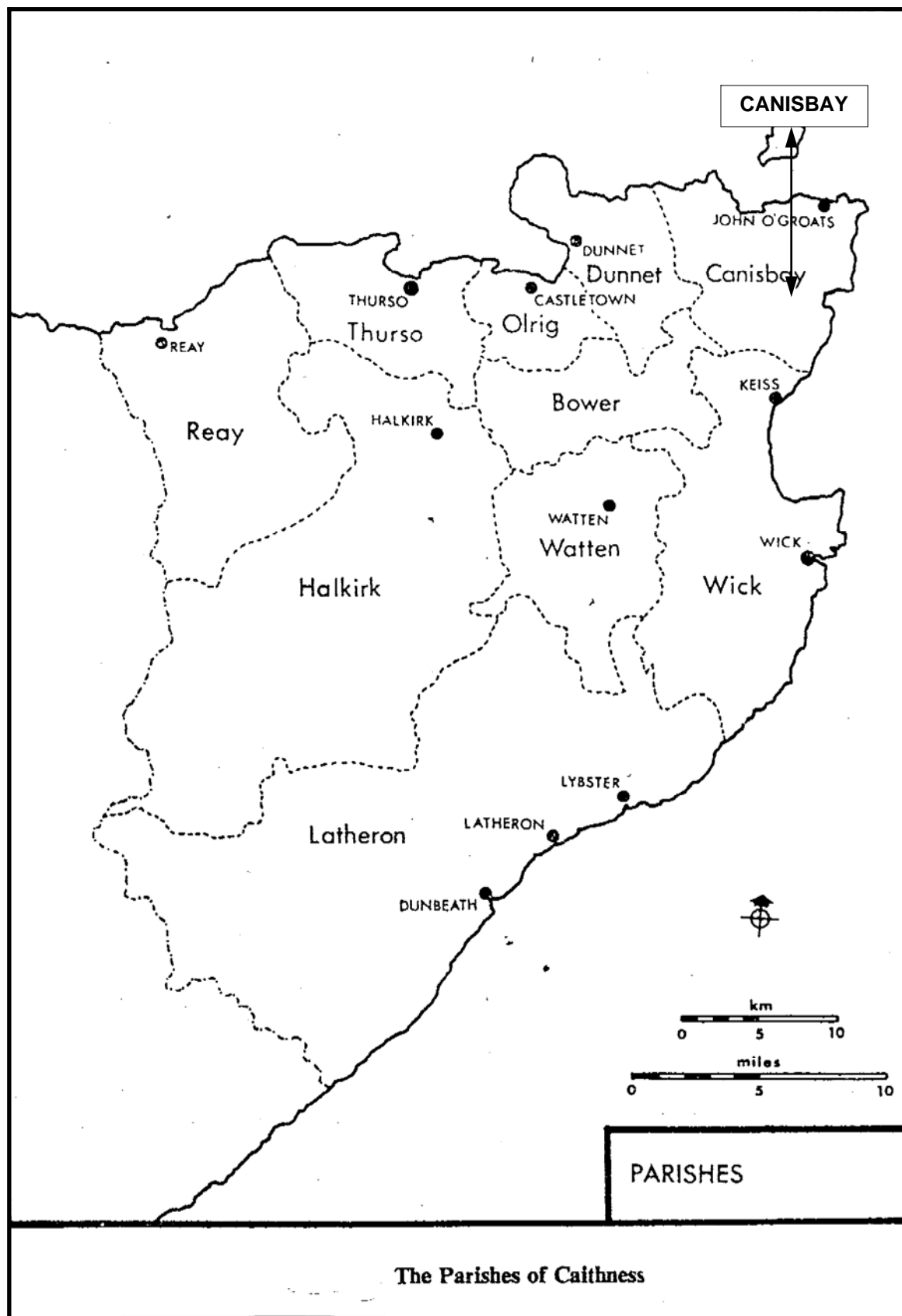

ANCESTORS - INTRODUCTION - Location

CAITHNESS

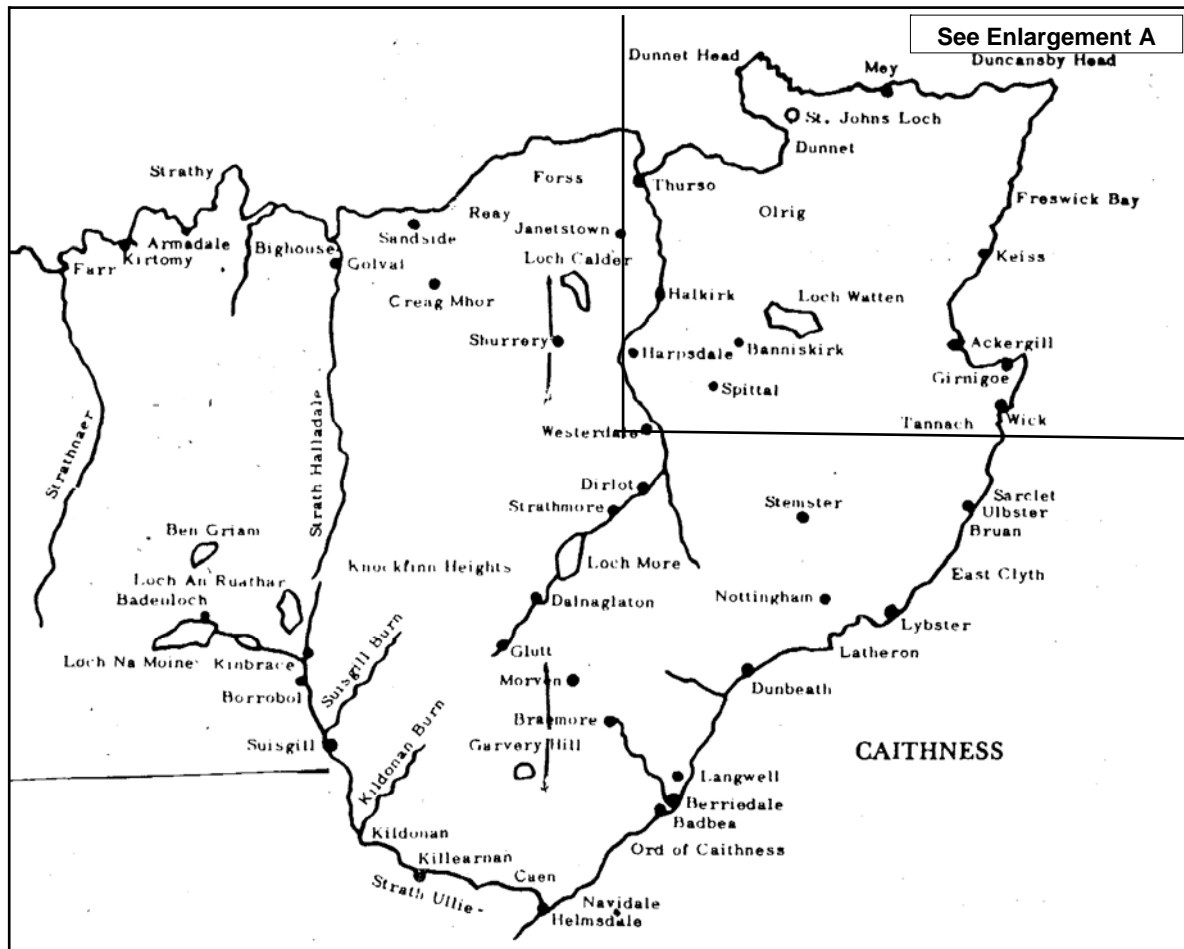

In a letter to her daughter, Flora Naylor, Helen wrote... "Dad (Donald) was from near Wick ten miles along the coast towards Thurso, and about 20 from Wick and 21 from Thurso. I was from between Duncansbay Head and Dunnet Head, Dad was from between Duncansbay Head and Moss Head to the East, I a bit further west both from the coast on Pentland Firth".

RELEVANT LOCATIONS

Auckingill - A very small village north of Wick.....served by a bus in the morning & evening from Wick.

- Residence of **Donald GUNN & Margaret KEITH** (G-4) , from 1774 to unknown....Christening of their child, **Margaret** (G-4.11) in 1774.
- Residence of **Peter GUNN & Margaret MANSON** (G-3) , from 1782 - Pre 1851....Christening of their children, **Donald** (G-3.1) in 1782; **Gavin** (G-3.2) in 1785; **Margaret** (G-3.3) in 1787; **Helen** (G-3.4) in 1789; **John** (G-3.5) in 1792; **Gavin** (G-3.6; G-2.0) in 1794; **William** (G-3.7) in 1798.
- Residence of **Gavin GUNN & Janet STEPHEN** (G-2) , 1821-1828...Christening of their child, **Peter** (G-2.1; -1.0) in 1821.
- Residence of **Peter GUNN & Alexandrina ROBERTSON** (G-1), 1846 - 1910....Christening of their children, **David** (G-1.2) in 1846; **Margaret** (G-1.3) in 1849; **Donald** (G-1.4; 0.0) in 1853; **Murdoch** (G-1.5) in 1857; **Janet** (G-1.6) in 1860; **Alexandrina** (G-1.7) in 1864.....Death of **Peter GUNN** (G-1) in 1884; Death of Alexandrina in 1910.

- ⇒ **The cottages** (since demolished) of Peter & Alexandrina GUNN, Gavin & Janet GUNN, William & Janet GUNN - In 1989 Bernard Thompson met a Mrs Matheson, postmistress, who knew of their location. She also had photographs taken at the turn of the century.
- ⇒ **A bungalow** which has a plaque "WG 1906" on the side of it...perhaps where William GUNN lived ...quite likely a descendant of Peter or William GUNN, sons of William GUNN & Janet BAIN.

ANCESTORS - INTRODUCTION - Location

RELEVANT LOCATIONS

Bernard Thompson - Auckengill

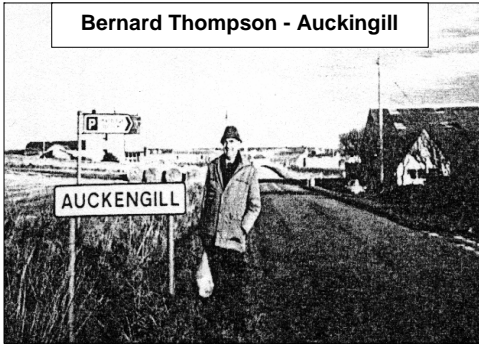

"The Milton" - Auckengill

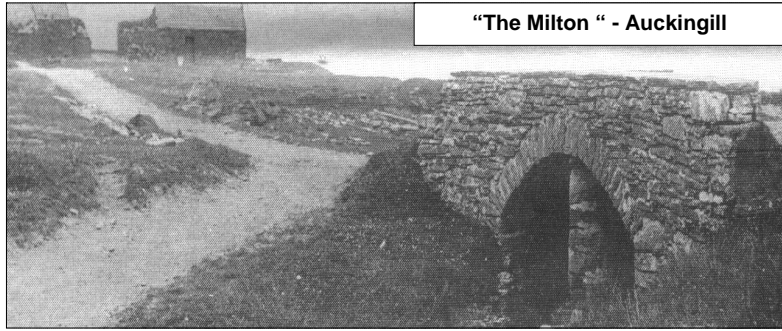

Banniskirk Mains Farm

- Donald GUNN (G-1.5.1.2) worked there as grieve.

Barrogil Farm

- Mac WATERS (B-1.9.1.3.) worked there before going to Canada.
- Now part of the Queen Mother's estate.

Canisbay

- Marriage of Peter GUNN & Margaret MANSON, 1781 (G-3).
- Marriage of Gavin GUNN & Janet STEPHEN, 1820 (G-2).....Burial of Gavin GUNN, 1828 & Janet STEPHEN, 1822.

The Post Office and general store of Mr Donald Swanson Auckengill



- Residence of George BAIKIE & Mary DUNNETT (B-5) , 1708 - 1721....Christening of their children, Agnes (B-5.1) 1708; John (B-5.2) 1711; Walter (B-5.3;-4.0) 1713; Magnus (B-5.4) 1716; Christian (B-5.5) 1721.
- Burial (No. 49) of George BAIKIE 1802 (B-3) .
- Burial (No.50) of James BAIKIE, 1912 & Catherine CALDER (B-1) 1921.
- Memorial to (No.50) of Benjamin BAIKIE (B-1.2) 1877.
- Burial (No.50) of John Calder BAIKIE (B-1.6) 1885.

Dunfermline

- North of Edinburgh - Descendants of Janet GUNN / William BLYTH (G-1.6) ??.

Dunnett

- Memorial to Thomas SWANSON (B-1.1).1881 & Burial of James SWANSON (B-1.1.2) 1891.
- (Hillhead)...Residence of Catherine BAIKIE & Capt. Alexander CALDER (??-??) (B-1.5).
- Burial of Catherine BAIKIE, 1938 & Capt. Alexander CALDER, 1925 (B-1.5).

Canisbay Church

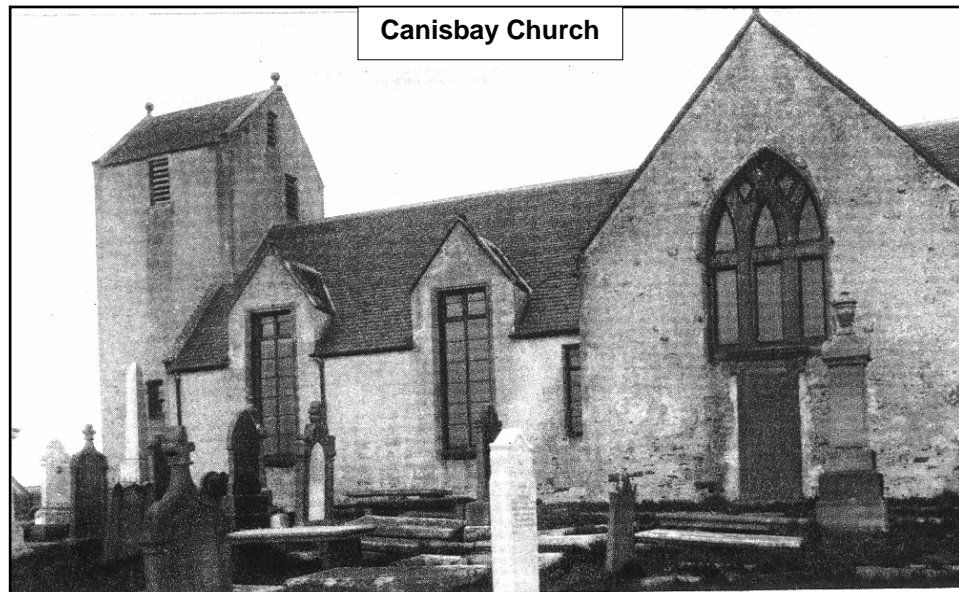

Canisbay Church - Buried here :-

- * James Baikie (1912), Catherine (nee Calder) Baikie (1921) & their son, John, who died aged 17.
- * Also mentioned was their eldest son, Benjamin Baikie, who was drowned in the Bay of Biscay (1877).
- * George Baikie (1802).
- * Gavin Gunn (1828), Janet (nee Stephen) Gunn (1822).

ANCESTORS - INTRODUCTION - Location

RELEVANT LOCATIONS

Halkirk

- **(Bower)**...Marriage of **Peter GUNN & Alexandrina ROBERTSON (G-1)**.....Residence of **Peter GUNN & Alexandrina ROBERTSON 1844 - 1845**....Christening of their child, **Gavin (G-1.1;)** 1845.
- Residence of **Margaret GUNN (G-1.3)**
- **(51 Bridge St.)**...Residence of **Donald GUNN & Helen MOWAT (G-1.5.2)** .
- Burial of of **Donald GUNN, 1980, & Helen MOWAT, 1981, (G-1.5.2)** .
- Other descendants of **Donald GUNN / Helen MOWAT & Murdoch GUNN / Margaret SUTHERLAND** here.



Halkirk Church & Churchyard



Keiss - around 1900

Keiss - About 2 miles SW from Auckingill....Just north of the village is the small cemetery.

- Burial of **Peter GUNN, 1903 & Alexandrina ROBERTSON, 1910 (G-1)**.
- Burial (unmarked) of **Murdoch GUNN (G-1.5)** 1927.
- Burial of **Murdoch GUNN, 1922 & Margaret GEDDES, 1952 (G-1.5.1)**.



Scarfskerry - The Linkmoor wrecked at Scarfskerry Pier

Thurso - Clayhusbandry (E. of Thurso)

- Residence of **Catherine BAIKIE & Capt. Alexander CALDER (B-1.5)**, (?? - 1925 / 1938)....died there .



Old Church. Thurso



High St., Thurso in 1900

Watten

- Residence of **Donald GUNN & Margaret KEITH (G-4)** , 1760-1772.....Christening of their children, **Peter (G-4.7; G-3.0)** 1762; **Donald (G-4.8)** 1765; **Ingram (G-4.9)** 1767; **John (G-4.10)** 1771.

Wick

- Marriage of **Charles GUNN & Margaret CORMACK, (G-5)** 1719.....Residence of **Charles GUNN & Margaret CORMACK, 1720 - ??**.....Christening of their children, **Katherine (G-5.1)** 1720; **Donald (G-5.2;G-4)** 1721; **George, (G-5.3)** 1723.
- Residence of **Donald GUNN & Margaret KEITH (G-4)** , 1749 -1759....Christening of their children, **John (G-4.1)**, 1750; **William (G-4.2)** 1752; **Elspeet (G-4.3)** 1755; **Mary, (G-4.4)** 1755; **Elspeet (G-4.5)** 1756; **Charles (G-4.6)** 1759.
- Home of the HERITAGE CENTRE in Bank Row - the largest museum in the north of Scotland.

ANCESTORS - INTRODUCTION -Location

RELEVANT LOCATIONS

Mey

- Marriage of **Walter BAIKIE & Catherine DUNNETT**, 1749 (B-4).....Residence of **Walter BAIKIE & Catherine DUNNETT**, 1750 - 62.....Christening of their children, **George** (G-4.1;-3.0) 1750; **Katherine** (B-4.2) 1759; **Mary**, (G-4.3) 1762.
- (**Mill of Mey**)....Residence of **Katherine BAIKIE** (B-4.2) 1841; **Mary BAIKIE** (G-4.3) 1841.
- Marriage of **George BAIKIE & Margaret SUTHERLAND**, 1765 (B-3).....Residence of **George BAIKIE & Margaret SUTHERLAND**, 1765 - 1802.....Christening of their children, **Elsbet**,(B-3.1) 1766; **James**, (B-3.2) 1767; **Margaret**, (B-3.3) 1769; **Janet**, (B-3.4) 1771; **Charlotte**, (B-3.5) 1773; **Margaret**,(B-3.6) 1776; **John**, (B-3.7) 1778; **Benjamin**, (B-3.8;-2.0) 1781; **George**, (B-3.9) 1787.
- Residence of **Benjamin BAIKIE & Helen BARNESTON** (B-2) 1824 - post 1861....Christening of their children, **George**,(B-2.1) 1824; **James**, (B-2.2;-1.0) 1825; **Magnus**, (B-2.3) 1828; **Benjamin**, (B-2.4) 1828; **Helen**, (B-2.5) 1831.

North West of Mey - Harrow Harbour / Tang Head - see Enlargement B / aerial photograph for the location of the cottages, and each individual person's story for a photograph.

- 1. **Castle Of Mey / Barrogill Castle** - "The Queen Mother's Caithness home lies in a secluded spot overlooking the Pentland Firth. It was built between 1566 & 1572 by the 4th Earl of Caithness, but had fallen into disrepair when the Queen Mother bought it in 1952, shortly after the death of King George VI. Since then she visited the castle annually. (From the Book "Caithness From The Air")
- 2. **Harrow Farm** - Residence of the **HAM** family.
- 3. **Rosebank** - Residence of **Margaret GEDDES & James GEDDES** (Ge.1.4.1.4.) .
- 4. **Pearl Cottage** - Residence of **Magnus BAIKIE & Jane GEDDES** (B-1.9) .
- 5. **Lowland Cottage** - Residence of **John GEDDES & Christine FORSYTH** (Ge.1.4.2.) .
 - - Now has a large extension on the right. The original cottage now a garage and store.
- 6. **Rose Cottage** - quite near Pearl Cottage.....
 - ⇒ Residence of **James BAIKIE & Catherine CALDER** (B-1) 1854 - 1912 / 21 (Probably = "Field of Harrow" ...Christening / Birth of their children, **Jane**,(B-1.1) 1855; **Benjamin**, (B-1.2) 1856; **Helen** (Helen Millar, nee Carter, = "The house grandma was born in"), (B-1.3;0.0) 1858; **Georgina**, (B-1.4) 1860; **Catherine**, (B-1.5) 1862; **Jemima**,(B-1.6) 1864; **Isabella**, (B-1.7) 1866; **John Calder**, (B-1.8; 1868; **Magnus**, (B-1.9) 1870; **George**, (B-1.10) 1872.
 - ⇒ Residence of **George BAIKIE & Georgina WALLACE** (B-1.10) - 1935/1939.
 - ⇒ At the time of Helen Millar's visit in 1951, the **SIMPSON** family were living there - the Simpson boys were close friends of Mac. Baikie.
- 7. **Tang Head** - Perhaps the residence of **Jane BAIKIE & Thomas SWANSON** (B-1.1), 1879 - 1880
 - Residence of **James BAIKIE & Margaret HAM** (B-1.9.2.) .
 - Now the exterior is as it was, but painted white.
- 8. **The Mill** - Owned & run by **John GEDDES & Jean HAM** (Ge.1.4. / Gen.-2).
William GEDDES & Isabella LEITH (Ge.1.4.2.11. / Gen.-2.2.11.).
 - Now converted to a dwelling.
- 9. **Cliff Cottage** - Perhaps the residence of **Catherine BAIKIE & Capt. Alexander CALDER** (B-1.5).
 - Residence of **John GEDDES & Jean HAM** (Ge.1.4. / Gen.-2).
 - Residence of **William GEDDES & Bella LEITH** (Ge.1.4.2.11. / Gen.-2.2.11.).
 - On Bella's death it passed to his son, **Sandy GEDDES**, (Ge.1.4.2.11.4.) , and on Sandy's death it passed to his sister, **Margaret DUNNET** (Ge.1.4.2.11.3.) in Orkney - they use it as a holiday cottage. It has been recently refurbished.
- 10. **White Cottage** - Residence of **Andrew GEDDES & Isabella JACK** (Ge.1.4.8. / Gen.-2.8.)
 - OR nearby ruins (See map).
 - Now has a new roof - used for storage / Berty Skene lives there ??
- 11. Residence of **Margaret GEDDES & William DUNNET** (Ge.1.4.8.5.) .
- 12. Residence of **Bella GEDDES & Robert SKENE** (Ge.1.4.8.8.) .

From the photo of the Mill of Mey area - See over ...

- **The Moorings** - Was the house of **Capt. George SUTHERLAND** (son of **Maggie LEITH**, a sister of **Bella LEITH** - Ge.1.4.2.11) & his wife **Mary FINLAYSON** (**Bruce DAVIES**, B.-1.9.1.2.,- aunt).
- **The Camps** - Was also the property of **Capt. George SUTHERLAND** & his wife **Mary FINLAYSON** - lies immediately across the road from The Moorings.
- There are a number of new properties in the area, and most belong to people not originally from the area, enjoying a quiet retirement.

ANCESTORS - INTRODUCTION - Location

RELEVANT LOCATIONS

Mill of Mey area

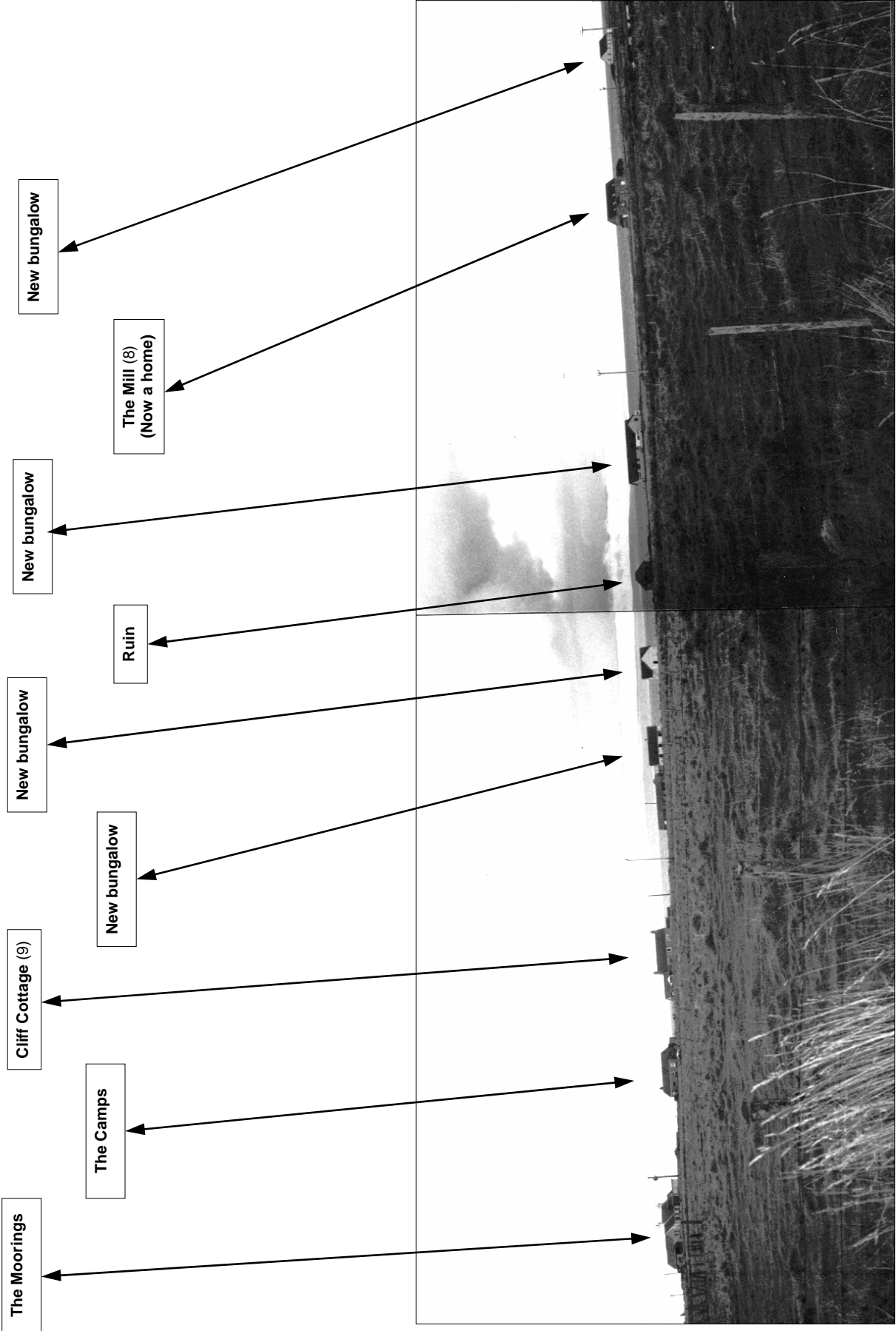

ANCESTORS - INTRODUCTION - Location

RELEVANT LOCATIONS

Harrow Harbour / Tang Head



(From the book "Caithness From The Air")

ANCESTORS - INTRODUCTION - Location

RELEVANT LOCATIONS

Castle of Mey



ANCESTORS - INTRODUCTION - "In a Nutshell"

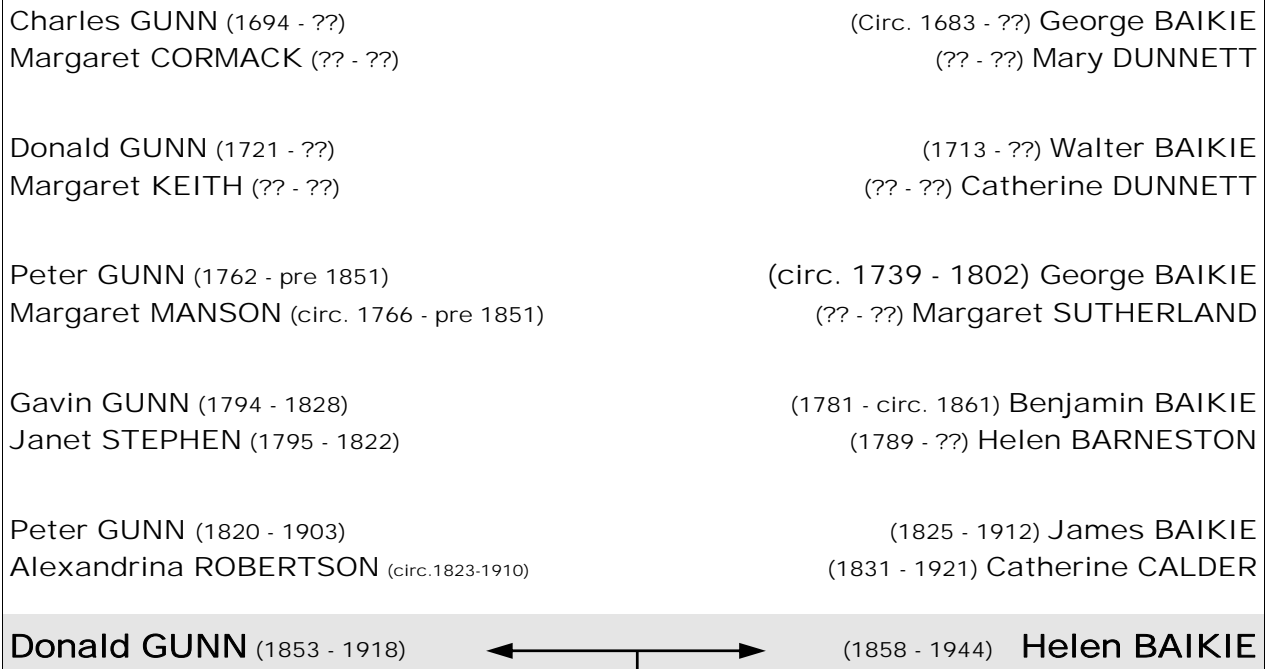

CHILDREN
Donald Murdoch GUNN - Ellen Royal McALLISTER
James Benjamin Baikie GUNN - Elsie Glasson BRAY
William Garden GUNN - Arita CHANTRIL / Rae TURNBULL
Cathrien Jenny GUNN - William Alexander CARTER
Helen Alexandrina GUNN - Peter Thomas ROBERTSON
Jessie Georgina GUNN - William Albert Edgar NANKIVELL
Ronald Calder GUNN - Ella Lamont GRAY
Rhoda May GUNN - Claude Albert HILL
Margaret Isabella GUNN - Robert George THREADGOLD
Ann Dorothy Jemima GUNN - Audrey Frank Edwin MARTIN
Flora Agnes GUNN - Lawrence James NAYLOR

ANCESTORS - INTRODUCTION

Donald & Helens' Brothers & Sisters

GUNN

Peter GUNN & Alexandrina ROBERTSON had 6 children :-

NAME	BORN	MARRIED	DIED
**Gavin GUNN	08/01/1845	—————	Not Known
**David GUNN	Circ. 1846	—————	Not Known
**Margaret GUNN	Circ. 1849	—————	Not Known
Donald GUNN	04/10/1853	Helen BAIKIE	11/06/1918
*Murdoch GUNN	19/12/1857	Margaret SUTHERLAND	19/08/1927
**Janet GUNN	18/05/1860	William BLYTH	1944 - Emigrated to USA
*Alexandrina GUNN	05/12/1864	George BREMNER	Not Known

BAIKIE

James BAIKIE & Catherine CALDER had 10 children :-

NAME	BORN	MARRIED	DIED
*Jane BAIKIE	05/03/1855	Tom SWANSON	28/02/1902
**Benjamin BAIKIE	19/10/1856	—————	07/03/1877
Helen BAIKIE	30/12/1858	Donald GUNN	01/07/1944
*Georgina C.BAIKIE	05/11/1860	John LEYLAND	06/01/1937
**Catherine BAIKIE	04/07/1862	Captain CALDER	19/12/1955 - No Issue
**Jemima BAIKIE	10/04/1864	Henry GUNN	Post 1933
**Isabella BAIKIE	04/04/1866	John SINCLAIR	12/07/1929 - No Issue
**John Calder BAIKIE	30/06/1868	—————	17/10/1885
*Magnus BAIKIE	28/06/1870	Jane GEDDES	13/09/1955
**George BAIKIE	20/11/1872	Georgina WALLACE	23/12/1939 - No Issue

Research so far :-

- * = We have a tree and / or considerable biography.
- ** = We have a rudimentary tree and / or basic biography.

There is a lot of ancestral research still to do, necessitating a trip to Scotland.

It was with these “distant cousins” that correspondence, visits & friendships took place between cousins in the UK and Australia (see over), thus maintaining links with the “home country”, in particular through :-

Marg Threadgold
Flora Naylor
Helen Millar
Bernard Thompson
Murray Hill
Gavin Martin

Unfortunately, as the older generations pass away, much of it will be lost - a good reason to “do a family tree” to remind us and our children / grandchildren of our roots.

ANCESTORS - INTRODUCTION

Extended Family Relationships

It was with many of our "distant cousins" that correspondence & visits took place between cousins in the UK & Australia.

Below is what we know of so far of Donald & Helen's family who corresponded with, or visited, or became friends with, of some of Donald & Helen's brothers & sisters as well as more distant Geddes cousins :-

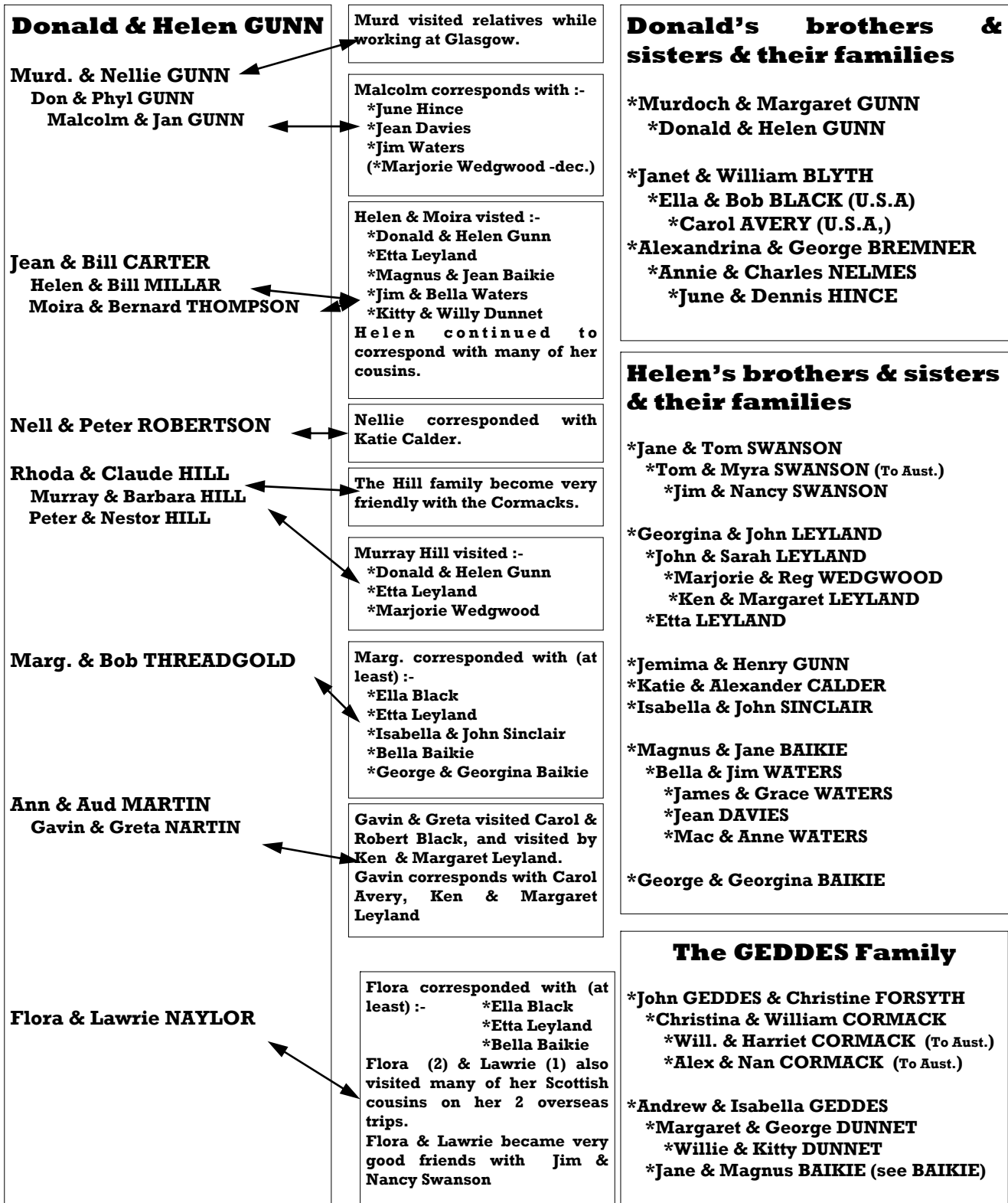

ANCESTORS - INTRODUCTION

Extended Family Relationships

**The key extended family relationships
"Where they fit"**

— = Descendants
— = Married

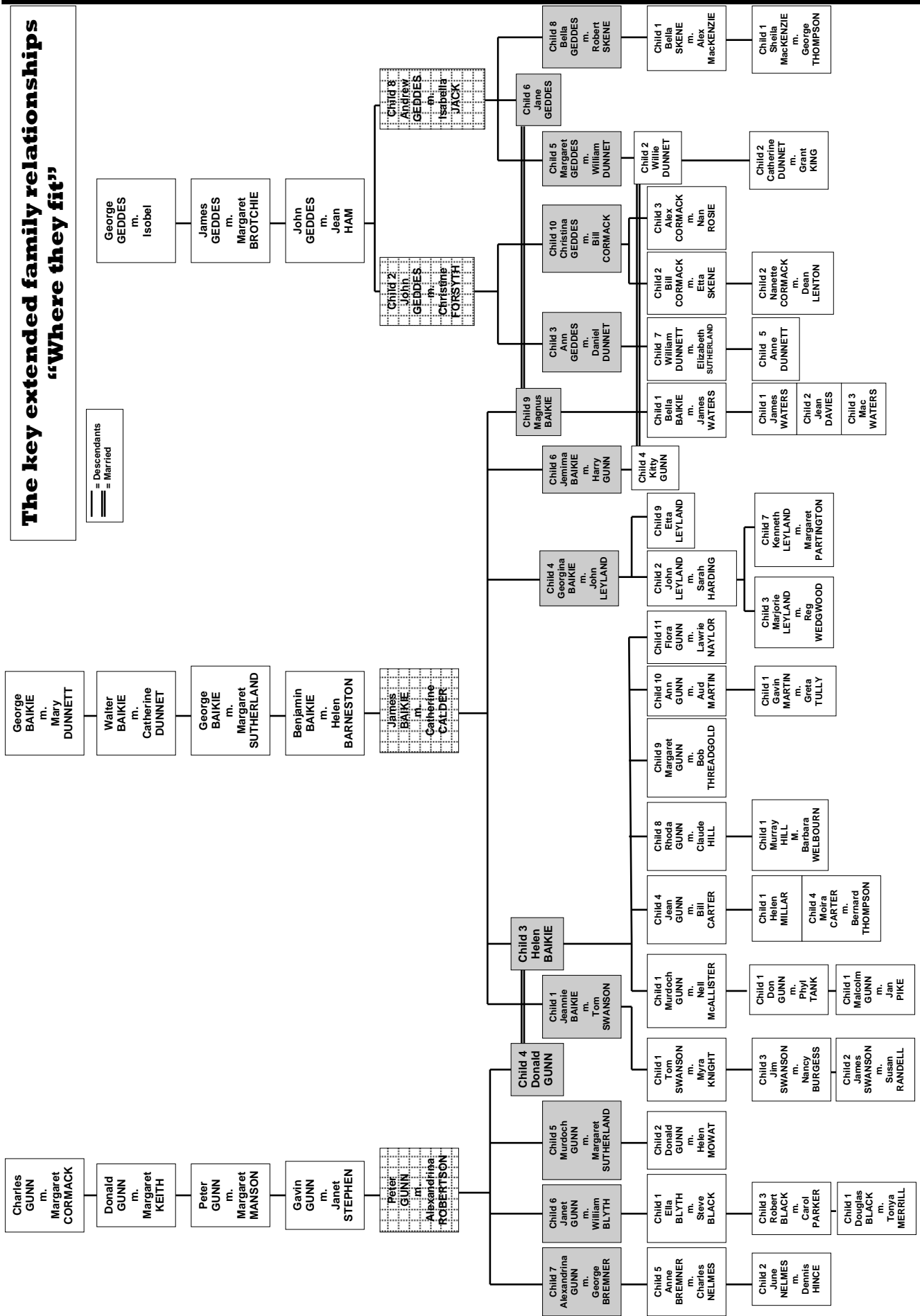

ANCESTORS - GUNN

INTRODUCTION

A full history of the Gunn's is pending the outcome of the petitions re the Chieftanship to the Lord Lyon, and ensuing publication of the History of the Clan Gunn by David Gunn. The following are some highlights taken mainly from "The Clan Gunn and its Country" published by the Clan Gunn Centre.

- **The Gunn clan is of Norse origin.**

- **Badge** :- Aitinn (Juniper) or Lus nan laoch (Roseroot).

- **Territory** :- The Gunns were a warlike clan mainly of the Highlands of Caithness & Sutherland. Their connection with the county as a distinct clan ended about 1619. (Henderson-"Caithness Family History", pp319)

- **The name** was derived from the Norse word "gunnr-war", "gunn-arr", "gunn-bjorn", "gunn-laug", "gunn-olfr". "Gunn" is an old West Scandinavian personal name. The Norse diminutive is "Gunna", whence the Gaelic "Guinne", with adjectival "Gunnach".



"Either peace or War"

The chiefship of the the Clan has been dormant for over a 100 years. The head of the Clan, in the absence of a recognized chief, is Iain Gunn of Banniskirk, who was appointed Commander (or Ceann Cath) of the Clan Gunn in 1972 by the Lord Lyon King of Arms. At the present moment, petitions are with The Lord Lyon "trying to establish the best line" for the Clan Chief.

Naming children :-

- ⇒ Eldest **son** named after father's father.
- ⇒ 2nd eldest son named after mother's father.
- ⇒ 3rd eldest son named after father.

- ⇒ Eldest **daughter** named after mother's mother.
- ⇒ 2nd eldest daughter named after father's mother.
- ⇒ 3rd eldest daughter named after mother.

THE CLAN GUNN SOCIETY

The first Clan Gunn Society was founded in Caithness in 1821 as the Loyal and United Benevolent Society of the Clan Gunn. A second Society was established in London in the late 19th century and the present Society was **reconstituted in Edinburgh in 1960** with the following objectives:—

1. to promote a spirit of kinship amongst members of the Clan throughout the world.
2. to assist in establishing the chiefship of the Clan.
3. to establish a Clan Centre as a meeting place, library and museum.
4. to acquire and preserve places and relics of interest to the Clan.
5. to assist members of the Clan with genealogical research.
6. to publish a history of the Clan.
7. to encourage the recovery and settlement of Clan lands.

The Society has an elected Council which normally meets six times a year in London to administer the affairs of the Society. There are also local Councils in London and Edinburgh which provide activities for members in the areas. Close links are maintained with the Clan Gunn Society of North America and with clansmen in Canada, Australia and New Zealand.

An international Gathering of the Clan is held in Caithness every three/four years.

Iain Gunn of Swiney House, Banniskirk, is the **Commander of the Clan Gunn**.

The Clan Gunn Heritage Centre is established in the Old Parish Church at Latheron in Caithness, and open to the public. The Centre which is administered by the Clan Gunn Heritage Trust, a charitable trust set up by the Society under the chairmanship of the Commander of the Clan, houses an exhibition describing the history of the Clan from its Norse origins to the present day and also a study area for members of the Clan who wish to examine the historical and genealogical records of the Clan.

The Gunn's were NOT descended from Olaf the Black as is part of folk-lore...From an article by Michael J. Gunn - "Olaf The Black and the Clan Gunn", in "The Gunn Herald", Sept. 2001 in which he refutes the origin of the Clan Gunn to a person named Gunni, who it is said was a son of Olaf the Black, Norse king of Man in the early thirteenth century, ...**"It may be stated with a good degree of certainty, that the Clan Gunn are descended from Gunni Andresarson (died 1226), a great Caithness magnate whose wife, Ragnhild, was the youngest sister of Harald the Young, who was created Earl of Caithness by William the Lion, and a grand-daughter of Rognvald Kali Lolsson, Jarl of Orkney / Caithness. So do the Clan Gunn have any blood - connection with Olaf the Black ? The answer, is yes....Gunn's sons, Snaekol and Andres Gunnasson were both fourth cousins once removed of Olaf the Black through their common descent from Thorfinn the Mighty, Jarl of Orkney / Caithness, who died in 1064. Thorfinn had two sons, Erlend and Paul; Snaekol's mother, Ragnhild, was g-g-granddaughter of Erlend Thoeirinnsson, and Olaf the Black was g-g-grandson of Paul Thorfinnsson. Olaf the Black almost certainly met Gunni Anfresarson during his sojourn at William the Lion's court, 1208- 1214; and he must have met Gunni's son, Snaekol in bergen in 1231, when the latter was on trial for the murder of Jarl jon of Orkney / Caithness"**.

ANCESTORS - GUNN

INTRODUCTION - A BRIEF HISTORY

- The Clan Gunn claims descent from...

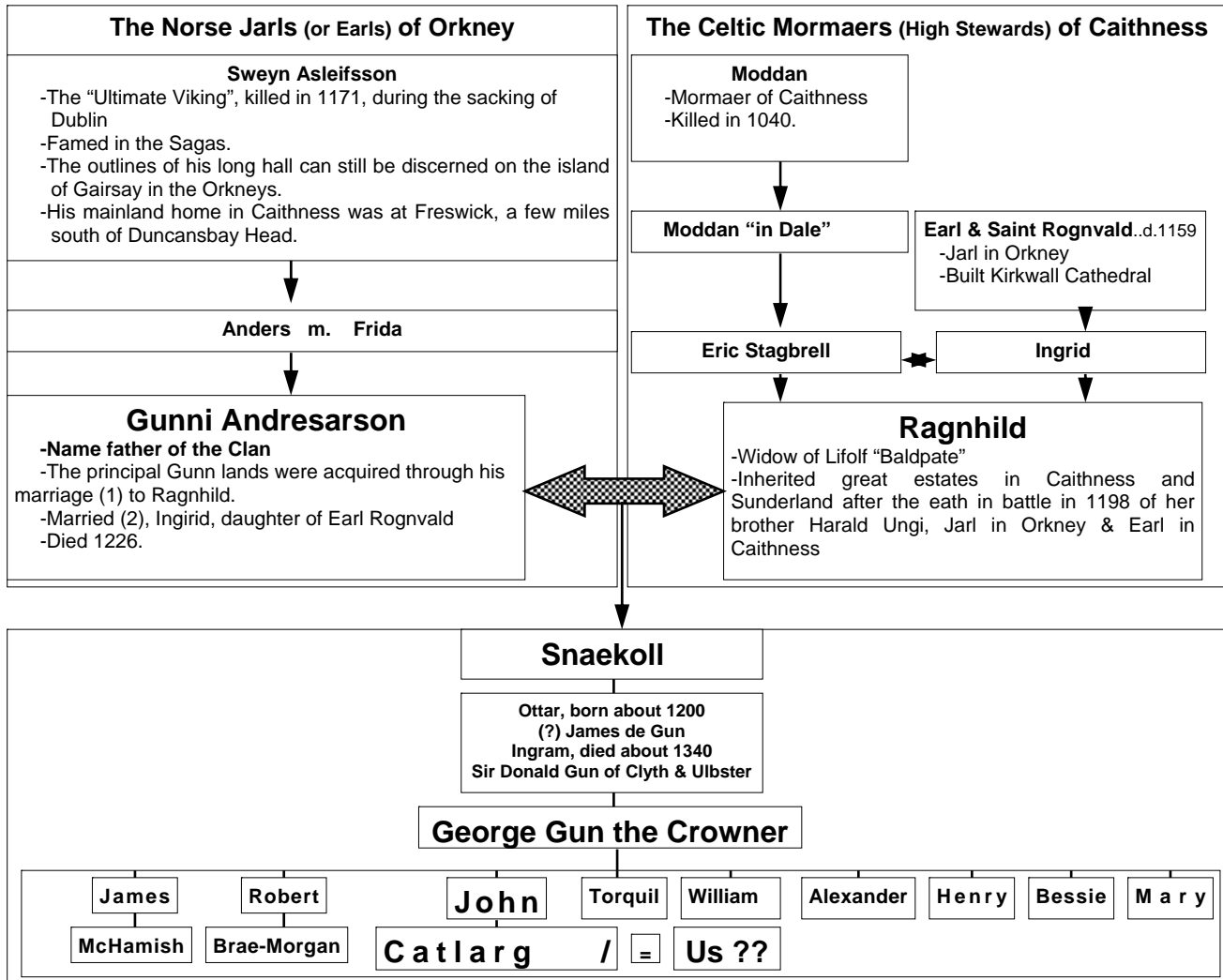

- 13th Cent.....** Thus from the middle of the 13th century the Gunns were essentially a Caithness family. The large estates were inherited by **Snaekoll** (White head - died about 1230) **Gunni's-son, the second chief of the Clan**. His rights to the Norse Earldom were, however, forfeited as he had murdered John, the then Jarl in Orkney, over a land claim dispute arising from their mutual descent from the ancient Jarls of Orkney. **At this time the Clan Gunn were at the height of their power.** They appeared to possess virtually the whole of Caithness, which was then passing from the influence of the Norse Earldom, to that of the King of Scots. Snaekoll Gunni's-son is reputed to have built Castle Gunn at Bruan, on the east' coast of Caithness south of Wick. There is a tradition that Castle Gunn was destroyed by the King of Norway, whose daughter one of the Gunn chiefs had married, though he already had a wife at Castle Gunn. When the second wife sailed to Caithness to join her husband, the Gunn clan arranged for the beacon to be placed on a dangerous rock at Ulbster and so wrecked the ship and all aboard were drowned. The castle was destroyed in revenge and the Gunn chief and his retainers were slain.
- 14th / 15th Cent. - Little is known of the history of the Clan during the 14th century** and it is not until **the 15th century that history records the exploits of the Clan and its chiefs.** However, **the Gunns & the Keiths were forever at enmity.....**Lachlan Gunn of Braemor had only one daughter, Helen, who was famous for her beauty, and the day of her marriage with her cousin Alexander was fixed; but Dugald Keith, a retainer of Keith of Ackergill, whose advances she had repelled, surrounded her father's house with a body of armed Keith's, slew many of the Gunns, who were unprepared for an attack, and carried off the girl to Ackergill, where she became the victim of her abductor, and eventually threw herself from the summit of the tower. Raid upon raid ensued now, and during one of these, in 1426, a desperate battle was fought between the two clans at Harpsdale, eight miles from Thurso. The conflict was rancorous and bloody, but indecisive. Another encounter occurred on the Muir of Tannach in 1438, where the Gunns were defeated. Nonetheless, **it is clear that during the 14th and 15th centuries the Gunns were gradually dispossessed of their lands in the fertile parts of Caithness by the Sinclairs, Keiths and others,** who obtained grants of land from the Scottish kings, anxious to increase their influence over the fringes of their kingdom.

ANCESTORS - GUNN

INTRODUCTION - A BRIEF HISTORY

- **15th Cent.**.....About the middle of the fifteenth century, the chief of the clan was George, who lived with barbaric pomp in his castle at Clyth. from the office he held, he was known as Crouner Gunn (Coroner of Caithness), but by the natives as "Am Braisteach Mor" or "Big Broochy" = "The big brooch", from a large silver brooch which fastened his plaid (the official badge of the Coroner was a great buckle of Celtic design). He held his main lands at Ulbster and Clyth on the rocky coast of Caithness, and the majority of the Clan by then occupied the highland regions of Caithness in what are now the Parishes of Latheron, Halkirk and Reay. **It was George Gunn, the Crouner**, who weary of the feud and after these many skirmishes with the Clan Keith over rival land claims, sought to settle it amicably and reach a conciliation with the Keiths at St. Tayre's Chapel, near Ackergill Tower, the seat of Keith of Ackergill in 1478 (other say 1464). He was killed in the unequal battle at the chapel where the Keiths arrived for the twelve-a-side parlay with twenty four men - two on each horse - and attacked the Gunns; the latter fought desperately, and were cut to pieces. George Gunn was slain and stripped of his arms, armour and brooch. His death was avenged by his grandson, but the feud continued. In 1578 the Earl of Kintore, Chief of Clan Keith and Iain Gunn of Banniskirk, the Commander of Clan Gunn, signed a Treaty of Friendship between the two clans at the site of the chapel, bringing to end the 500 year old feud.

- **16th Cent.** - Soon after, William Mackames, a kinsman of the Keiths, killed George of Ackergill, and his son, with ten men, at Drummay. A greater part of the clan migrated to Sutherland afterwards...In the latter half of the sixteenth century, the Gunns quarrelled with the Earls of Caithness & Sunderland. By magnificent archery, however, they defeated the combined forces of their enemies at Aldgowne.

- **17th Cent.** - Sir William Gunn of this clan fought valiantly under Gustavus Adolphus. In 1636 on the plains of Weslock, he was chiefly instrumental in defeating the Austrians. Charles 1 knighted him for bravery.

- **After the death of George, the Crouner**, and his sons at Ackergill, **the Clan split into three distinct families** -- **James or Seumas**, the Crouner's eldest son who survived the battle, moved with his family to **Kildonan in Sutherland**, subsequently known as Gleann na Guineach or Quint's Glen, where he obtained lands from the Earls of Sutherland; **Robert**, the second surviving son established his line in **Braemore**, in the southern heights of Caithness as the Robson Gunns, and **John**, the third surviving son settled in **Cattaig** or Bregual in Strathrnore, in the higher reaches of the River Thurso above Westerdale. The Mac Sheumais (or McHarnish) Gunns continued to live in Strath Kildonan, first at Killearman and later at Badenloch at the top of the Strath, until the old line died out in 1782.

- **Other Gunn families established themselves at** Crosskirk, near Forss, on the north coast of Caithness and in Reay, Strathy and Strath Halladale in the Mackay country. The various chieftains leased their lands from the Chiefs of Clan Sutherland and Clan Mackay and in turn sublet these to their immediate families who subdivided them among their families. There was, however, **a surprising amount of movement from one part of the country to another** and so it cannot be assumed that all Gunns in one area were necessarily all of the same branch of the family.

INTRODUCTION - SEPTS

Many clansmen do not bear the surname of Gunn. Surnames were not commonly used until comparatively recent times. They would have been of little use where everybody was of the same clan. A man or a woman was therefore known as John or Jean mac Sheumais or mac Dhaidh, son or daughter of James or David, of Clan Gunn, and when a surname came to be used, many adopted their father's name and hence John or Jean Robson, Georgeson, Williamson etc. The Sept names recognized as being associated with the Clan Gunn are as below. Where Sept names are common to other Clans, it is likely that those who have a tradition of having originated north of the Caledonian Canal are Gunns.

Allisterson	Gaunson	MacComas	Mackeamish	Mains	Sandison
Anderson	George	MacCorkill	Mackean	Mann	Swan
Croner	Georgeson	MacCorkle	Mackendrick	Manson	Swann
Crouner	Henderson	MacCullie	MacMains	Maness	Swanney
Crowner	Inrig	MacDade	MacNeil	Manus	Swanson
Cruiner	Jameson	MacDhaidh	MacOmish	More	Thomson
Cruner	Jamieson	MacEnrick	MacRob	Neilson	Tomson
Eanrig	Jamison	MacGeorge	MacRory	Nelson	Will
Enrick	Johnson	MacHarnish	MacSheoras	Robinson	Williamson
Galdie	Keen	MacManus	MacWilliam	Robeson	Wills
Gallie	Keene	MacIain	Magnus	Robison	Wilson
Gailey	MacAllister	MacKarnes	Magnusson	Robson	Wyllie
Ganson	MacChruner	Mackeamis	Main	Rorieson	Wyllie
Gauldie					

ANCESTORS - GUNN

Donald's Great, Great, Great, Grandparents (G.-5.)

CHARLES GUNN (b. cir1694) & MARGARET CORMACK

CHRONOLOGY

<u>CODE</u>	<u>WHO</u>	<u>EVENT</u>	<u>WHEN</u>	<u>WHERE/COMMENT / SOURCE</u>
G-5.	GUNN, Charles	<u>Born</u>	Circ. 1694	Scotland.....OPR
		<u>Married</u>	22/01/1719	Wick, Scotland.....IGI - Pat Sub.No.7021714
		<u>Occupation</u>		Not Known
		<u>Residence(s)</u>		Halster, Scotland.....OPR
		<u>Died</u>	Not Known	
		<u>Buried</u>	Not Known	
	CORMACK, Margaret	<u>Born</u>	Not Known	Parents perhaps, George & Katherine Cormack....Clan Gunn Film
		<u>Occupation</u>		Probably Home Duties
		<u>Died</u>	Not Known	
		<u>Buried</u>	Not Known	

Parish registers for Wick, county of Caithness did not commence until 1701, so it will be rather difficult to go back any earlier, unless there are wills or else they appear on Family Trees of the Clan Gunn Society or other publications. If the Scottish tradition of naming the eldest son after his grandfather is followed, then Charles' father = Donald.

CHARLES & MARGARET GUNN - Their Family

CHRONOLOGY

<u>CODE</u>	<u>WHO</u>	<u>EVENT</u>	<u>WHEN</u>	<u>WHERE / COMMENT / SOURCE</u>
G-5.1	GUNN, Katherine	<u>Born</u>	1720	Scotland.....OPR (Clan Gunn Film 1368497)
		<u>Christen.</u>	07/02/1720	Wick, Scotland.....IGI - Pat. Sub.No.7021714
G-5.2 (G-4.0)	GUNN, Donald	<u>Born</u>	1721	Scotland.....OPR (Clan Gunn Film 1368497)
		<u>Christen.</u>	31/07/1721	Wick, Scotland.....IGI - Pat. Sub.No.7021713
G-5.3	GUNN, George	<u>Born</u>	1723	Scotland.....OPR (Clan Gunn Film 1368497)
		<u>Christen.</u>	17/02/1723	Wick, Scotland.....IGI - Pat. Sub.No.7027901
		<u>Married</u>	02/12/1748	Perhaps <u>Margaret CORNER</u> Wick, Scotland.....OPR (Clan Gunn Film 1368497)
G-5.3.1	GUNN, Charles	<u>Christen.</u>	17/04/1757	Scotland.....OPR (Clan Gunn Film 1368497)

ANCESTORS - GUNN

Donald's Great, Great, Grandparents (G.-4.) DONALD GUNN (b.1721) & MARGARET KEITH CHRONOLOGY

<u>CODE</u>	<u>WHO</u>	<u>EVENT</u>	<u>WHEN</u>	<u>WHERE/COMMENT / SOURCE</u>
G-4. (G-5.2)	GUNN, Donald	<u>Born</u>	1721	Scotland.....OPR (Clan Gunn Film 1368497)
		<u>Christened</u>	31/07/1721	Wick,Scotland.....IGI - Pat. Sub.No.7021713
		<u>Married</u>	05/12/1749	Wick,Scotland.....IGI - Pat. Sub.No.7022213
		<u>Occupation</u>		Porbably a Crofter
		<u>Residence(s)</u>		1749-1762, Wick 1762-1774, Tails of Watten,Watten 1774-??, Auckingill, Canisbay.....OPR (Clan Gunn Film 1368497)
		<u>Died</u>	Not Known	
		<u>Buried</u>	Not Known	
	KEITH, Margaret	<u>Born</u>	Not Known	Perhaps, Father = John Keith.....IGI-Pat.Sub.No.7022213
		<u>Occupation</u>		Probably Home Duties
		<u>Died</u>	Not Known	
		<u>Buried</u>	Not Known	

DONALD & MARGARET GUNN - Their Family CHRONOLOGY

<u>CODE</u>	<u>WHO</u>	<u>EVENT</u>	<u>WHEN</u>	<u>WHERE / COMMENT / SOURCE</u>
G.-4.1	GUNN,John	<u>Christen.</u>	14/01/1750 or 51	Monsequoey,Wick,Scotland.....OPR (Clan Gunn Film 1368497)
		<u>Died</u>	Pre-1771	
G.-4.2	GUNN,William	<u>Christen.</u>	17/11/1752	Haster,Wick,Scotland.....OPR (Clan Gunn Film 1368497) / IGI - Pat. Sub. No. 7021713
	(?? William)	<u>Christen.</u>	06/12/1752	Olrig.....IGI - Pat. Sub. No.7611162
G.-4.3	GUNN,Mary	<u>Christen.</u>	05/02/1755	Haster,Wick,Scotland.....OPR (Clan Gunn Film 1368497) / IGHl - Pat. Sub. No.7211224
G.-4.4	GUNN,Elspet	<u>Christen.</u>	05/02/1755	Haster,Wick,Scotland.....OPR (Clan Gunn Film 1368497) / IGI - Pat. Sub. No.7021713 / 7211224
		<u>Died</u>	Pre-1756	
G.-4.5	GUNN,Elspet(h)	<u>Christen.</u>	04/05/1756	Haster,Wick,Scotland.....OPR (Clan Gunn Film 1368497) / IGI - Pat. Sub. No. 7211713
G.-4.6	GUNN,Charles	<u>Christen.</u>	10/06/1759	Bilpster,Wick,Scotland.....OPR (Clan Gunn Film 1368497) / IGI - Pat. Sub.No.721124
		<u>Married</u>	24/01/1783	Ann Nicholson.....IGI - Pat. Sub.No.721124
G.-4.7	GUNN,Peter	<u>Christen.</u>	12/08/1762	Tails of Watten, Watten,Scotland.....OPR (Clan Gunn Film 1368497 / IGI - Pat.Sub.No.7333419
(G.-3.0)				
G.-4.8	GUNN,Donald	<u>Christen.</u>	11/05/1765	Eastside,Watten,Scotland.....OPR (Clan Gunn Film 1368497 / IGI - Pat. Sub. No. 7333419
G.-4.9	GUNN,Ingram	<u>Christen.</u>	22/03/1767	Eastside,Watten,Scotland.....OPR (Clan Gunn Film 1368497 / IGI - Pat. Sub. No. 7333419
G.-4.10	GUNN,John	<u>Christen.</u>	27/04/1771	Coscride,Watten,Scotland.....OPR (Clan Gunn Film 1368497 / IGI - Pat. Sub. No. 7333419
G.-4.11	GUNN,Margaret	<u>Christen.</u>	10/05/1774	Auckingill,Canisbay,Scotland.....OPR (Clan Gunn Film 1368497 / IGI - Pat. Sub.No.7518201

Donald & Margaret did not follow the traditional naming pattern for at least one of their children.....the Mormon film shows that Margaret's father was John Keith, but the John christened at Watten on 27/04/1771 was their 6th or 7th son. Their first son was William (not sure about the John christened 1750), but we do not know whether Donald's grandfather was called William. However, the Charles christened at Wick (?) on 10/06/1759 was the second son and so does follow the traditional naming pattern.

So the likely time sequence for Donald & Margaret is...

1721	Donald born at Wick - parents Charles Gunn & Margaret Cormack.
pre 1749	Donald living at Blinzery, Wickthen part of parish of Thurso ??
1749	Donald marries Margaret Keith at Wick .
1750-59	Donald (29 yrs. old) & Margaret living at Wick :- John born 1750 (baptised Monsequoey) - died pre 1771 William born 1752 (baptised Haster) Mary born 1755 (baptised Haster) Twin Elspet also born 1755 but died before 1756 ?? Elspet born 1756 (baptised Haster) Charles born 1759 (baptised Bilpster)
1760-72	Donald (39 yrs. old) & Margaret living at Watten :- Peter born 1762 (Baptised Tails of Watten) Donald born 1765 (Baptised Eastside) Ingram born 1767 (Baptised Eastside) John born 1771 (Baptised Coscride of Watten)
1774-	Donald(53. yrs old) & Margaret living at Auckingill :- Margaret born 1774 (Baptised at Auckingill)

ANCESTORS - GUNN

Donald's Great Grandparents (G.-3.)

PETER GUNN (1762 -Pre 1851) & MARGARET MANSON (Circ. 1766 - Pre 1851)

CHRONOLOGY

<u>CODE</u>	<u>WHO</u>	<u>EVENT</u>	<u>WHEN</u>	<u>WHERE/COMMENT / SOURCE</u>
G-3. (G-4.7)	GUNN, Peter	<u>Christened</u>	12/08/1762	Tails of Watten, Watten, Scotland OPR (Clan Gunn Film 1368497)
		<u>Married</u>	07/12/1781	Canisbay, Scotland.....IGI
		<u>Occupation</u>		Farmer.....Census 1841
		<u>Residence(s)</u>		Auckingill, Canisbay, Caithness, Scotland..... OPR / Census 1841
		<u>Died</u>	Pre 1851	Auckingill, Canisbay..... OPR / Census 1841 / 1851
		<u>Buried</u>	Not Known	
	MANSON, Margaret	<u>Born</u>	Circa 1766OPR / Census 1841
		<u>Occupation</u>		Probably Home Duties
		<u>Died</u>	Pre 1851	Auckingill, Canisbay..... OPR / Census 1841 / 1851
		<u>Buried</u>	Not Known	

PETER & MARGARET GUNN - Their Family

CHRONOLOGY

<u>CODE</u>	<u>WHO</u>	<u>EVENT</u>	<u>WHEN</u>	<u>WHERE / COMMENT / SOURCE</u>
G.-3.1	GUNN, Donald	<u>Born</u>	Circ. 1782	Auckingill, Canisb., Caithn., Scot.....Clan Gunn Film 1368497
		<u>Married</u>	04/05/1807	<u>Alexandrina MANSON</u>IGI
		<u>Died</u>	1870	88yrs.; Auckingill, Canisb., Scot.....IGI / Clan Gunn Film 1368497
G.-3.2	GUN(N), Gavin	<u>Christen.</u>	11/02/1785	Auckingill, Canisb., Caithn., Scot.....IGI / Clan Gunn Film 1368497
		<u>Died</u>	Pre 1794	2nd. Gavin born in 1794
G.-3.3	GUN(N), Margaret	<u>Christen.</u>	02/07/1787(6?)	Auckingill, Canisb., Caithn., Scot.....IGI / Clan Gunn Film 1368497
		<u>Married</u>	29/07/1815	<u>John BAIN</u>IGI
		<u>Died</u>	Circ. 1869	Auckingill, Canisb., Caithn., Scot.....I.Aitchison
G.-3.4	GUN(N), Helen	<u>Christen.</u>	03/05/1789	Auckingill, Canisb., Caithn., Scot.....IGI / Clan Gunn Film 1368497
		<u>Residence</u>		With parents.....Census 1841 / 1851
		<u>Died</u>	04/05/1872	"Pauper"; Auckingill, Canisb., Caithn, Scot..... OPR / Clan Gunn Film 368497
		<u>Buried</u>	??/05/1872	Auckingill, Canisb., Caithn., Scot.....35/17 - I.Aitchison
G.-3.5	GUNN, John	<u>Christen.</u>	06/01/1792	Auckingill, Canisb., Caithn., Scot.....IGI / Clan Gunn Film 1368497
		<u>Married</u>		<u>Jane (Jean)CAMPBELL</u>Perhaps 6 children...I.Aitchison
		<u>Died</u>	1863	Glasgow, Scotland..... OPR Clan Gunn Film 1368497
G.-3.6 (G.-2.0)	GUNN, Gavin	<u>Christen.</u>	11/08/1794	Auckingill, Canisb., Caithn., Scot.....IGI / Clan Gunn Film 1368497
		<u>Died</u>	1828	Auckingill, Canisb., Caithn., Scot.....IGI / Clan Gunn Film 1368497
G.-3.7	GUNN, William	<u>Christen.</u>	09/06/1798	Auckingill, Canisb., Caithn., Scot.....IGI / Clan Gunn Film 136849
		<u>Married</u>	01/01/1825	<u>Janet BAIN</u> : Canisbay.....I. Aitchison
		<u>Died</u>	02/04/1860	Auckingill, Canisb., Caithn., Scot..... OPR / Clan Gunn Film 1368497
		<u>Buried</u>	??/04/1860	Canisbay

ANCESTORS - GUNN

Donald's Great Grandparents - **PETER & MARGARET GUNN**

So the likely time sequence for Peter & Margaret is :-

1762	Peter Gunn born at Watten - parents Donald Gunn & Margaret Keith.
1774	Peter moved to Auckingill with parents.
1781	Peter (19 yrs old) marries Margaret Manson at Canisbay. 1782 Donald born....married Alexanderina Manson. 1785 Gavin born....died pre 1794 (2nd Gavin born). 1786 Margaret born.....married John Bain. Died approx. 1869. 1789 Helen born....died in 1872, single, 83 yrs old and a pauper at Canisbay. 1792 John born - married Jane (Jean) Campbell - they had 6 children. Died in 1863 at Glasgow. 1794 Gavin born...see next story. 1798 William born....married Janet Bain.
1841	Peter (79 yrs old) & Margaret (app. 80 yrs old) living as farmers at Auckingill with daughter Helen (but age does not match with census age) and grandson Peter, whose parents, Gavin & Janet died in 1828 & 1822 respectively.
pre 1851	Both Peter & Margaret have died... not in the 1851 census.

Two of Peter & Margaret's children are of interest ...

- **Their eldest son ,Donald,** is of interest because of his family's connections with Australia - two of Donald and Alexanderina's children "stretched" to Australia...
 - ⇒ **One of their daughter's, Margaret** married **Kenneth Budge** - their fourth child, also named **Margaret, married John Cudmore and moved to Goolwa South Australia.**
 - ⇒ **Their youngest son, William...**
 - *In about 1855, he deserted ship in Australia.
 - *In about March 1864, his wife Mary and his daughter Rachel arrived in South Australia on the "Ocean Chief" (their 2nd daughter, Helen born 13/2/1856 died in Scotland before 1864).
 - *While they lived at Goolwa, they had two more children..
Ellen Louisa Gunn (3/6/1865).....(Deborah Patterson's of USA-greatgrandmother)
William Cudmore Gunn (16/1/1868)...(Christine Bartlett's, South Australia, great grandfather).
 - *They then moved to a property near Wentworth NSW.
 - *While there William was kicked by horse and died on 14th Dec 1869.
 - *He was buried on the property, Middle Yards.
 - *Another son, John Henry was born soon after on 17/3/1870.
 - *Mary subsequently married Henry Greene and John Kingsbury.

Mrs Matheson, postmistress at Auckingill and now deceased, informed Bernard Thompson ...

- * Of a photo taken near 1900 at Keiss , showing some of the descendants of William & Janet.
- * Of the cottages (since demolished) in Auckingill of Gavin Gunn / Janet Steven (William's elder brother) & his son Peter Gunn / Alexandrina Robertson, as well as that of William Gunn / Janet Bain.
- * Of a bungalow nearby which had a plaque "WG 1906" on the side of it - probably where a William Gunn lived - quite likely a descendent of Peter or William Gunn, the sons of William Gunn and Janet Bain.

ANCESTORS - GUNN

Donald's Grandparents (G.-2.)

GAVIN GUNN(1794-1828) & JANET STEPHEN(1795-1822)

CHRONOLOGY

<u>CODE</u>	<u>WHO</u>	<u>EVENT</u>	<u>WHEN</u>	<u>WHERE/COMMENT / SOURCE</u>
G-2.	GUNN,Gavin	<u>Christen.</u>	11/08/1794	Auckingill,Canisb.,Scotland.....IGI / <i>Clan Gunn Film1368497</i>
		<u>Married</u>	19/02/1820	Canisbay,Scotland.....IGI / <i>OPR (Clan Gunn Film 1368497)</i>
		<u>Occupation</u>		Fisherman.... <i>OPR (Clan Gunn Film 1368497)</i>
		<u>Residence(s)</u>		Auckingill, Canisbay..... <i>OPR (Clan Gunn Film 1368497)</i>
		<u>Died</u>	1828	Aged 34 yrs. : Auckingill
STEPHEN, Janet		<u>Buried</u>	1828	Canisbay (No.120)..... <i>Monumental Inscriptions</i>
		<u>Born</u>	1795	
		<u>Occupation</u>		Home Duties
		<u>Died</u>	1822	Agrd 27 yrs
		<u>Buried</u>	1822	Canisbay (No.120)..... <i>Monumental Inscriptions</i>

GAVIN & JANET GUNN - Their Family CHRONOLOGY

<u>CODE</u>	<u>WHO</u>	<u>EVENT</u>	<u>WHEN</u>	<u>WHERE / COMMENT / SOURCE</u>
G-2.1 (G-1.0)	GUNN,Peter	<u>Christen.</u>	11/01/1821	Auckingill,Canisb.,Scotland.....IGI / <i>Clan Gunn Film1368497</i>
		<u>Married</u>	02/11/1844	<u>Alexandrina ROBERTSON</u> : Bower, Canisbay,ScotlandIGI / <i>OPR Clan Gunn Film 1368497</i>
		<u>Occupation</u>		Fisherman
		<u>Died</u>	20/10/1903	Auckingill, Canisbay
		<u>Buried</u>	??/10/1903	Keiss (No. 149)..... <i>Monumental Inscriptions</i>

Gavin & Janet deserve a special place in the family tree, because they only had two years of married life and had only one son Peter (baptised 11/01/1821).

Janet died in 1822 at the early age of 27 and **Gavin died in 1828** at the age of 34.

In the 1841 Census, there appears "*Peter*" aged 20 registered as "*son*" living with Peter Gunn & Margaret Manson, Gavin's parents. More than likely this is Peter & Margaret's grandson, and Gavin & Janet's only son Peter.

Gavin was a fisherman, and was **buried at Canisbay** next to his nephew Peter Gunn and family.

ANCESTORS - GUNN

Donald's Parents (G.-1.)

PETER GUNN (1820-1903) & ALEXANDRINA ROBERTSON (Circ. 1823-1910)

CHRONOLOGY

CODE	WHO	EVENT	WHEN	WHERE/COMMENT / SOURCE
G-1.	GUNN, Peter	<u>Christen.</u>	11/01/1821	Auckingill, Canisb., Scotland.... <i>IGI / Clan Gunn Film 1368497</i>
		<u>Married</u>	02/11/1844	Bower North, Caithness(No.149) <i>IGI / OPR (Clan Gunn Film 1368497)</i>
		<u>Occupation</u>		Fisherman.... <i>Census</i>
		<u>Residence(s)</u>		Auckingill, Canisbay..... <i>OPR (Clan Gunn Film 1368497) / Census 1851/61/71</i>
		<u>Died</u>	20/10/1903	Auckingill, Canisbay..... <i>Family</i>
		<u>Buried</u>	??/10/1903	Keiss (No. 149) <i>Monumental Inscriptions</i>
	ROBERTSON, Alexandrina	<u>Born</u>	Circ.1823	Bower Halkirk..... <i>Family</i>
		<u>Occupation</u>		Home Duties
		<u>Died</u>	1910	Auckingill, Canisbay..... <i>Family</i>
		<u>Buried</u>	1910	Keiss (No. 149) <i>Monumental Inscriptions</i>

PETER & ALEXANDRINA GUNN - Their Family CHRONOLOGY

CODE	WHO	EVENT	WHEN	WHERE / COMMENT / SOURCE
G.-1.1	GUNN, Gavin	<u>Christen.</u>	08/01/1845	Bower, Caithness, Scot..... <i>IGI</i>
		<u>Died</u>	Not Known	
		<u>Did not marry</u>		
G.-1.2	GUNN, David	<u>Born</u>	Circ. 1846	Auckingill, Canisbay, Caithness, Scot..... <i>Census</i>
		<u>Died</u>	Not Known	
G.-1.3	GUNN, Margaret "Maggie"	<u>Born</u>	Circ. 1849 02/10/??	Auckingill, Canisbay, Caithness, Scot..... <i>Census</i> <i>Flora Naylor Birthday Book</i>
		<u>Did not marry</u>		
		<u>Died</u>	Not Known	
G.-1.4	GUNN, Donald (G.0.0)	<u>Born</u>	04/10/1853	Auckingill, Canisbay, Caithness, Scot..... <i>IGI / Family</i>
		<u>Married</u>	25/12/1882	Helen BAIKIE....Port Adelaide, South Australia..... <i>Family</i>
		<u>Died</u>	11/06/1918	Monteith, South Australia..... <i>Family</i>
		<u>Buried</u>	??/06/1918	Murray Bridge, South Australia..... <i>Family</i>
G.-1.5	GUNN, Murdoch	<u>Born</u>	19/12/1857	Auckingill, Canisbay, Caithness, Scot..... <i>IGI / Census</i>
		<u>Married</u>	1884	Margaret SUTHERLAND <i>Family / Reg. Wick No. 28</i>
		<u>Occupation</u>		Estate Mason; Piper..... <i>Family</i>
		<u>Died</u>	19/08/1927	Aged 50..... <i>Family</i>
		<u>Buried</u>	??/08/1927	Keiss Cemetery...unmarked grave..... <i>Miss Bremner</i>
G.-1.6	GUNN, Janet	<u>Born</u>	18/05/1860	Auckingill, Canisbay, Caithness, Scot..... <i>IGI</i>
		<u>Married</u>	Circ. 1892	William BLYTH...Dunfermline..... <i>Family</i>
		<u>Occupation</u>		Probably Home Duties
		<u>Residence</u>		To USA..... <i>Family</i>
		<u>Died</u>	Not Known	USA..... <i>Family</i>
G.-1.7	GUNN, Alexanderina	<u>Born</u>	05/12/1864	Auckingill, Canisbay, Caithness, Scot..... <i>IGI</i>
		<u>Married</u>	Circ. 1894	George BREMNER..... <i>Family</i>
		<u>Died</u>	Not Known	
G.-1.?	GUNN, Peter	Flora Naylor's travel diary has Peter as one of Donald's brothers. Murray Hill also met a Peter Gunn, overseer at the Vicker's Estate between Wick & Thurso. Murray thought it was a cousin of his grand father, Donald. However, Donald's father, also called "Peter", was an only child.		

ANCESTORS - GUNN

Donald's Parents - **PETER & ALEXANDRINA GUNN**

So the likely time sequence for Peter & Alexandrina is :-

- 1820 **Peter born at Auckingill, Caithness.**
- 1822 **Peter's mother, Janet Stephen, dies.**
- 1828 **Peter's father, Gavin, dies.**
- 1828 **Alexandrina Robertson / Robison born at Bower Halkirk**
- 1841 **Peter, aged 20, living with grandparents Peter Gunn & Margaret Manson.**
- 1844 **Peter, 24, marries Alexandrina, 21, at Bower Halkirk**
 1845 Gavin born
 1848 David born
 1849 Margaret born
 1853 **Donald born**
 1857 Murdoch born
 1860 Janet born
 1864 Alexandrina born
- 1851 **Peter, 30, fisherman, living at Auckingill with Alexandrina, 28, & children:-**
 Gavin 6
 David 3
 Margaret 1
- 1861 **Peter, 40, fisherman, living at Auckingill with Alexandrina, 38, & children :-**
 (Gavin 16.....where ??)
 (David 13..... where ??)
 Margaret 11, scholar
 Donald 7
 Murdoch 3
 Jessie 10m.(= Janet)
- 1871 **Peter, 50, fisherman, living at Auckingill with Alexandrina, 49, & children :-**
 (Gavin 26....where ??)
 (David 23....where ??)
 Margaret 21, general servant
 (Donald 17....probably at sea)
 Murdoch 13, scholar
 Janet 10, scholar
 Alexandrina 6, scholar
 Also living with them was Helen, "pauper", as a lodger = Peter's great aunt (sister of great grandparent Donald) ??
- 1903 **Peter, 84, (tombstone shows 82) died and was buried at Keiss Cemetery, 2 miles south of Auckingill.**
- 1910 **Alexandrina, 87, dies and was also buried at Keiss Cemetery.**

ANCESTORS - BAIKIE

INTRODUCTION

From Dr. George Black - "Scottish surnames"...

- **The name** is from the old estate of BAIKIE in Angus
- In 1379, Henry St. Clair, Baron of Roslin, became Earl (or Jare) of Orkney. These Sinclairs had as an ancestor, the Fentons of Baikie, and may have taken some of these on their return to Orkney. Dr. Black states all Baikies can be traced to Orkney, but he did not know the Fenton of Baikie descent.
- Statements that Paul Baikie was King Haahon's pilot are wrong. The pilot's name was Paul Baekison, and his son would be called Paulson. Yet Magnus Baikie, founder of the main Baikie family, (Tankeners,cir. 1550), stated he was descended from Paul Balkison. He came from the district of BEAQUOY or BUCKQUOY in Birsay, and that is where Paul Balkison had his lands. He may have been descended in the female line. Also '*Beaaquoy/Buckquoy*' may originally have been '*Baikie-land*'.

From H.Taylor's research.....he has analysed the Canisbay/Dunnet Baikies...

- **From the IGI...** The dominant Christian name is George.....the earliest being 1708
Next is James.....the earliest being 1793
Next is John
A very early name is Harry, but he does not appear again.
- **These names are all Tankerness names**, except for a few coming in from the female side. The dominance of George may also suggest that they were Tankerness Baikies.
- **The Tankerness were a family of merchants**, later landed gentry, who date from about 1550 or so. They are now extinct in the male line in Orkney. There was a General Hugh Simpson-Baikie in New Zealand, about 1920...perhaps the last of them.
- **George Baikie of Tankerness**, 1640 -1720, was a "bad man". For the last 20 years of his life, the estate was out of his hands, probably through debt. He may have even been jailed. He had a large family and with the estate in debt, the younger sons would have had a hard time of it - no extra money for the young gentlemen to "lounge around". Being educated they would have made good tenants for large farms, and they may have been only too glad to cross over to Caithness from Orkney. The George, Harry, Henry of around 1710, born 1670-80 perhaps were sons of George Baikie of Tankerness.

From "The Weekly Scotsman" 08/11/1951 :-

- This is **one of the oldest Orcadian names**. According to Torfaeus (An Icelandic Scholar and Antiquary, 1640-1719, studied at Copenhagen), Paul Baikie was King Haakon's pilot in 1263.
- The **present family trace their descent from Magnus Baikie**, who held lands in Birsay in 1533, and who claimed descent from the pilot.
- A **grandson of Magnus, James** born 1590, **acquired the property of Tankerness** which continued in the family's possession until it was sold in 1951.
- Many of the family have held public office....**Robert Baikie** was elected **M.P. for Orkney & Shetland** in 1780.
- **William Balfour Baikie** (1825 - 1864), was an Orcadian, born at Kirkwall in 1825, and surgeon in the Royal Navy. He was attached to the Niger Expedition in 1854, and ultimately commanded it - explored a great part of the Nile and Shadda country, opening the region up . He later published an account of the voyage.

ANCESTORS - BAIKIE

INTRODUCTION

“Maritime & Marital Connections” Of the **BAIKIE'S, SWANSONS, GEDDES (+ JACKS, SINCLAIRS)**

JOHN SWANSON
(1760-pre 1858)
Farmer.

THOMAS SWANSON
(1800-1874)
Master mariner, crofter, fisherman.

JAMES SWANSON
(1834-1876)

Died at sea off Thurso on schooner "Lizzie" owned by Mrs Janet Swanson. (On Govt. Register till 1922.)

JANET SINCLAIR

1)MARGARET CALDER

JANET SINCLAIR

*BROTHER **CAPT. GEORGE SINCLAIR**
(1845-1913)... "The Bailie".
Owner "Janet Sinclair", "Lizzie" & "Sunshine", "Henry Florence".

*SISTER **ELIZABETH SINCLAIR**
Married **Donald Jack** (1833-c1905) and
Captain, "Sunshine".

2)MARJORY BAIN.....

THOMAS SWANSON
*(1848-1881)

*Died at sea, Alloa to Shetland on schooner
"Janet Sinclair".

*(Govt. list of wrecks = "Captain T Swanson").

BENJAMIN BAIKIE
(1781- ?)
Crofter.

GEORGE BAIKIE
(1824-1908?)
Farmer, master mariner.
Owned "Barrogil Castle" (?1865-?).

HELEN BARNESTON

CHARLOTTE SUTHERLAND

JAMES BAIKIE
(1825-1912)

JANE BAIKIE..... **Jim Swanson** in Australia.
(1855-1902)

CATHERINE CALDER

BENJAMIN BAIKIE.....Washed overboard "Southern
(1856-1877) Cross".

HELEN BAIKIE

DONALD GUNN....On the ship "Southern Cross".

MAGNUS BAIKIE.....**Jean Davies & Mac Waters.**
(1870-1955)

JOHN GEDDES
(1789-1886)

GEORGE GEDDES
(1830-?)
Miller Thurso. Owned "Barrogil Castle"(1880-1892?).
Disappears from register in 1897.

JEAN HAM

ANDREW GEDDES
(1838-?)
Crofter, fisherman.
ISOBELLA JACK

JANE GEDDES
(?-1955)

OUR BAIKIE ANCESTORS

Helen's Great Great Great Grandparents (B.-5.)...Not 100% sure

GEORGE BAIKIE (b. circ. 1683) & MARY DUNNETT

CHRONOLOGY

<u>CODE</u>	<u>WHO</u>	<u>EVENT</u>	<u>WHEN</u>	<u>WHERE/COMMENT / SOURCE</u>
B-5.	BAIKIE, George	<u>Born</u>	Circ. 1683D. Armstrong
		<u>Married</u>	Circ. 1708D. Armstrong
		<u>Occupation</u>	Not Known	
		<u>Residence(s)</u>	Not Known	
		<u>Died</u>	Not Known	
		<u>Buried</u>	Not Known	
	<u>DUNNETT, Mary</u>	<u>Born</u>	Not Known	
		<u>Occupation</u>	Probably Home Duties	
		<u>Died</u>	Not Known	
		<u>Buried</u>	Not Known	

Tracing our very early Baikie ancestors has been the result of many people contributing to what has been a fascinating "jigsaw puzzle" and a very large Baikie tree, so it is worth repeating here the key researchers (in bold & underlined) and where they fit. The "**Baikie mothers**" are in bigger print & italicised...

-5	George BAIKIE / Mary DUNNETT									
-5	-4	Walter BAIKIE / Catherine DUNNETT								
-5	-4	-3	George BAIKIE / Margaret SUTHERLAND							
-5	-4	-3	-2	James BAIKIE / Esther JOHNSTON						
-5	-4	-3	-2	-1	James BAIKIE / Margaret CREAR					
-5	-4	-3	-2	-1	0	Margaret BAIKIE / Murdoch CAMPBELL				
-5	-4	-3	-2	-1	0	1	Margaret CAMPBELL / Robert MOIR			
-5	-4	-3	-2	-1	0	1	2	Elizabeth MOIR / Leslie WATTS		
-5	-4	-3	-2	Benjamin BAIKIE / Helen BARNESTON						
-5	-4	-3	-2	-1	James BAIKIE / Catherine CALDER					
-5	-4	-3	-2	-1	0	Helen BAIKIE / Donald GUNN				
-5	-4	-3	-2	-1	0	1	Donald Murdoch GUNN / Ellen Royal McALLISTER			
-5	-4	-3	-2	-1	0	1	2	Donald Allister GUNN / Phyllis Jean TANK		
-5	-4	-3	-2	-1	0	1	2	3	Donald Malcolm GUNN / Janice Kay PIKE	
-5	-4	-3	-2	-1	0	1	Cathrien Jenny (Jean) GUNN / William Alexander CARTER			
-5	-4	-3	-2	-1	0	1	2	Moira Jean CARTER / Francis Bernard THOMPSON		
-5	-4	-3	-2	-1	0	Georgina BAIKIE / John LEYLAND				
-5	-4	-3	-2	-1	0	1	John LEYLAND / Sarah HARDING			
-5	-4	-3	-2	-1	0	1	2	Marjorie LEYLAND / Reg WEDGEWOOD		
-5	-4	-3	-2	-1	0	Magnus BAIKIE / Jane GEDDES				
-5	-4	-3	-2	-1	0	1	Bella BAIKIE / James WATERS			
-5	-4	-3	-2	-1	0	1	2	James WATERS / Grace SHAW		
-5	-4	-3	-2	-1	0	1	2	Jean WATERS / Bruce DAVIES		
-5	-4	-3	-2	-1	0	1	2	Magnus (Mac) WATERS / Anne FINAN		
-5	-4	-3	-2	George Baikie / Isobel LEVOCK						
-5	-4	-3	-2	-1	John Baikie / Henrietta WARESTo South Africa.					
-5	-4	-3	-2	-1	0	George BAIKIE / Mary Anne COVENTRY				
-5	-4	-3	-2	-1	0	1	2	Eleanor BAIKIE / Arthur WRIGHT		
-5	-4	-3	-2	-1	0	1	2	3	Enid WRIGHT / Charles PILCHER	
-5	-4	-3	-2	-1	0	1	2	3	4	Jennifer PILCHER / Kurt STERN
-5	-4	Magnus BAIKIE / Catherine MALCOLMSON								
-5	-4	-3	John BAIKIE / Christina GRAY							
-5	-4	-3	-2	John BAIKIE / Christina MALCOLSON						
-5	-4	-3	-2	-1	Margaret BAIKIE / John BRUCE					
-5	-4	-3	-2	-1	0	John BRUCE / Alexina MALCOLMSON				
-5	-4	-3	-2	-1	0	1	Alexander BRUCE / Edith HALCRO....To Australia			
-5	-4	-3	-2	-1	0	1	2	Margaret BRUCE / Bruce MILLER		
-5	-4	-3	-2	-1	Ann BAIKIE / John STOUT					
-5	-4	-3	-2	-1	0	Mary Ann STOUT / Alexander STEWART				
-5	-4	-3	-2	-1	0	1	Annie STEWART / Sidney ARMSTRONG			
-5	-4	-3	-2	-1	0	1	2	Sidney ARMSTRONG / Noreen CUNDY		
-5	-4	-3	-2	-1	0	1	2	3	David ARMSTRONG	

GEORGE & MARY BAIKIE - Their Family

CHRONOLOGY

<u>CODE</u>	<u>WHO</u>	<u>EVENT</u>	<u>WHEN</u>	<u>WHERE / COMMENT / SOURCE</u>
B.-5.1	BAIKIE, Agnes	<u>Christen.</u>	30/10/1708	Canisbay, Caithness, Scotland.....D. Armstrong
		<u>Died</u>	Not Known	
B.-5.2	BAIKIE, John	<u>Christen.</u>	06/01/1711	Canisbay, Caithness, Scotland.....D. Armstrong
		<u>Died</u>	Not Known	
B.-5.3	BAIKIE, Walter	<u>Christen.</u>	05/07/1713	Canisbay, Caithness, Scotland.....D. Armstrong
(B.-4.0)		<u>Married</u>	29/11/1749	<u>Catherine DUNNETT</u> , Mey Scot.....D. Armstrong
		<u>Died</u>	Not Known	
B.-5.4	BAIKIE, Magnus	<u>Christen.</u>	24/04/1716	Canisbay, Caithness, Scotland.....D. Armstrong
		<u>Married</u>	12/10/1735	<u>Catherine MALCOLSON</u> , Longhope, Orkney, Scot.....D. Armstrong
		<u>Died</u>	Not Known	
B.-5.5	BAIKIE, Christian	<u>Christen.</u>	01/06/1721	Canisbay, Caithness, Scotland.....D. Armstrong
		<u>Married</u>	12/10/1735	Perhaps <u>Thomas DUNNETT</u>D. Armstrong
		<u>Died</u>	Not Known	

ANCESTORS - BAIKIE

Helen's Great Great Grandparents (B.-4.) ...Not 100% sure !! WALTER BAIKIE (b.1713) & CATHERINE DUNNETT

CHRONOLOGY

<u>CODE</u>	<u>WHO</u>	<u>EVENT</u>	<u>WHEN</u>	<u>WHERE/COMMENT / SOURCE</u>
B-4.	BAIKIE, Walter (BAIKY)	<u>Christen.</u>	05/07/1713	Canisbay, Caithness, Scotland.....Scots Ancestry Research Society: 4 North David Street, Edinburgh 2, Scotland25th August 1954 - Report on the ancestry of John Baikie who married married Henrietta Wares in Wick 1846.
		<u>Married</u>	29/11/1749	Mey, Scotland.....Scots Ancestry Research Society
		<u>Occupation</u>	Not Known	
		<u>Residence(s)</u>		Canisbay, Scotland....Scots Ancestry Research Society
		<u>Died</u>	Not Known	
		<u>Buried</u>	Not Known	
		<u>Born</u>	Not Known	
	DUNNETT, Catherine (Katherine)	<u>Occupation</u>	Probably Home Duties	
		<u>Died</u>	Not Known	
		<u>Buried</u>	Not Known	

The further we go back with our research, the more difficult & less sure it becomes. So for Walter, The Scots Ancestry Research Society, in their research for Baikie ancestors, found that...

Now the evidence is somewhat sketchy for many reasons, including ...

So sometimes "a bit of luck" helps, and that came in the form of a "scrap of paper with a list of the *Baikie mothers*", from Jennifer Stern, a very distant Baikie cousin in Zimbabwe, who had in her possession amongst her family papers showing ...

- "The records for Canisbay are unfortunately blank from 1722-47, the period during which George Baikie would most probably be born. They were, however, searched from 1747-50, and the following entry found :-

<i>George, son to Walter Baikie and Katherine Dunnet in Mey born September 11th and baptised 1750.</i>		
<i>Katharine</i>	<i>Born 2nd</i>	<i>Baptised 09:12:1759</i>
<i>Mary</i>	<i>Born 17th</i>	<i>Baptised 23:08:1762</i>
- And their marriage was recorded in Canisbay thus :-
"October 10th, 1749 Walter Baikie and Catharine Dunnet in Mey contracted and married November 29th."
- The Baikies have a Norse heritage, not Scottish.
- There are many gaps in the 18th century Parish Registers for various reasons.....loss, damage, destruction, religious disputes, the struggle between the Presbytery & Episcopacy in 17th/18th century.
- Leslie Watts, another distant Baikie cousin in England, found "...*The Church records in Inverness Library are almost unreadable prior to about 1750*".
- The Scots Ancestry Research Society states "*The records for Canisbay are unfortunately blank from 1722-47*"...destroyed or damaged or missing, the period during which George Baikie, would most probably be born."
- This period is between the Jacobite rebellions of 1715 & 1745 when there was considerable support in the north of Scotland for the Stuart pretenders to the throne. Other reports have suggested that a number of the churches in the mid eighteenth century were in severe states of disrepair and there were no incumbent priest to perform marriages and baptisms.
- **Henrietta Wares**..(married John Baikie).
- **Isobel Levoch**..(married George Baikie).
- **Margaret Sutherland**..(married George Baikie).
- **Katherine Dunnet**..(married Walter Baikie).

ANCESTORS - BAIKIE

Helen's G. G. Grandparents - **WALTER & CATHERINE BAIKIE**

Now the first three "*Baikie wives*", Henrietta Wares, Isobel Levoch, and Margaret Sutherland can be independently corroborated...that would make the fourth, Katherine Dunnett, fairly certain. In addition, the I.G.I. shows that Walter Baikie is the only Baikie married to a Katherine Dunnett in the mid 1700's. We don't have evidence as to when Walter died.

There is little doubt that a Walter Baikie did have a son George baptised in 1750...

- If George was born on that date this would make him only 14 1/2 on his marriage to Margaret Sutherland in 1765.
- George's death records indicate he was born around 1739.
- There is also the possibility of another George about 1739 whose parents were not Walter Baikie and Catherine Dunnet.
- The problem of George being born around 1739 and so 10 years before Walter & Catherine's marriage in 1749, may be explained by "hand-festing"....a form of marriage recognized by the state as being legitimate, yet not being recognized by the church. Hand festing involved the couple holding hands over water (often on a bridge) and swearing their love for each other. The Kirk often refused to baptize the children of such marriages until the marriage had been confirmed in church, perhaps by an itinerant priest So George may have been baptised after his parents marriage, aged 10.

The "naming pattern does not help much either...Of the three named children of Walter Baikie...

<u>1st son</u>	= named after paternal grandfather	= George , but we have no record of Walter's father.
If there were a...		
2nd son	= named after maternal grandfather	= We have no record of Katherine Dunnett's father.
3rd son	= named after father	= Perhaps would be named "Walter".
<u>1st daughter</u>	= named after maternal grandmother	= (K)Catherine , but we have no record of Catherine's grand mother
<u>2nd daughter</u>	= named after paternal grandmother	= Mary , but we have no record of Walter's father.
If there were a...		
3rd daughter	= named after mother	= Perhaps would be named "Catherine".

Walter's sisters were both unmarried and lived together at Mill of Mey (1841 Census) both aged 80 (D.O.B. = 1861) . The 1841 Census does not give marital status, relationship to the head of the household, and ages are rounded down to the nearest 5. So their ages cannot be taken to be accurate at face value, nor are we totally sure whether the Katherine and Mary here are sisters, sisters in law or cousins, but it is a strong probability.

WALTER & CATHERINE BAIKIE - Their Family

CHRONOLOGY

<u>CODE</u>	<u>WHO</u>	<u>EVENT</u>	<u>WHEN</u>	<u>WHERE / COMMENT / SOURCE</u>
G.-4.1	BAIKIE, George (G.-3.0) (BAIKY)	<u>Born</u>	11/09/??	Mey, Caithness, Scotland..... <i>Scots Ancestry Research Society</i>
		<u>Christen.</u>	1750	Mey, Caithness, Scotland..... <i>Scots Ancestry Research Society</i>
		<u>Married</u>	25/02/1765	<u>Margaret SUTHERLAND</u> , Canisbay, Caithness, Scotland..... <i>Scots Ancestry Research Society</i>
G.-4.2	BAIKIE, Katherine	<u>Died</u>	12/03/1802	63 yrs., Mey, Scotland..... <i>OPR / IGI</i>
		<u>Buried</u>	??/03/1802	No.49, Canisbay, Caithness, Scotland..... <i>MI</i>
		<u>Born</u>	02/??/??	Mey (?), Caithness, Scotland..... <i>Scots Ancestry Research Society</i>
		<u>Christen.</u>	09/12/1759	Mey (?), Caithness, Scotland..... <i>Scots Ancestry Research Society</i>
G.-4.3	BAIKIE, Mary (BAIKY)	<u>Residence</u>		Mill of Mey, Caithness (not married)..... <i>Census 1841</i>
		<u>Died</u>	Post 1841 <i>Census 1841</i>
		<u>Born</u>	17/??/??	Mey (?), Caithness, Scotland..... <i>Scots Ancestry Research Society</i>
		<u>Christen.</u>	23/08/1762	Mey (?), Caithness, Scotland..... <i>Scots Ancestry Research Society</i>
		<u>Residence</u>		Mill of Mey, Caithness (n.m. / With Katherine)..... <i>Census 1841</i>
		<u>Died</u>	Post 1841 <i>Census 1841</i>

ANCESTORS - BAIKIE

Helen's Great Grandparents (B.-3.)

GEORGE BAIKIE (Circ. 1739 - 1802) & MARGARET SUTHERLAND

CHRONOLOGY

<u>CODE</u>	<u>WHO</u>	<u>EVENT</u>	<u>WHEN</u>	<u>WHERE/COMMENT / SOURCE</u>
B-3.	BAIKIE, George (BAIKY)	<u>Born</u>	11/09/Circ 1739	Canisbay, Caithness, Scotland... <i>Scots Ancestry Research Society</i>
		<u>Christen.</u>	1750	Canisbay, Caithness, Scotland..... <i>Scots Ancestry Ancestry Research Society....see below</i>
		<u>Married</u>	27/01/1765	"Matrimonially contracted"..... <i>Scots Ancestry Research Society</i>
			25/02/1765	Mey, Scotland..... <i>Scots Ancestry Research Society / Patron Sub.IGI 7104027-Larson</i>
		<u>Occupation</u>		Farmer..... <i>Scots Ancestry Research Society</i>
		<u>Residence(s)</u>		Mey, Canisbay, Scotland..... <i>Scots Ancestry Research Society</i>
		<u>Died</u>	12/03/1802	Aged 62 yrs, Mey, Canisbay, Scotland.... <i>Scots Ancestry Research Society</i>
		<u>Buried</u>	??/03/1802	Canisbay, Scotland (No.49)..... <i>MI</i>
<u>SUTHERLAND,</u> <u>Margaret</u>		<u>Born</u>	Not Known	
		<u>Occupation</u>	Probably Home Duties	
		<u>Died</u>	Not Known	
		<u>Buried</u>	Not Known	

Reflections on George & Margaret's details.....again, it shows that we cannot always be 100% sure on family tree research...this is also the case with **George & Margaret...the data gathered so far...**

SCOTS ANCESTRY RESEARCH SOCIETY REPORT FOR DAVID H BAIKIE :-

"Scots Ancestry Research Society: 4 North David Street, Edinburgh 2, Scotland.....25th August 1954 Report on the ancestry of John Baikie who married Henrietta Wares in Wick 1846."

- "The old parochial registers of Wick were then searched from 1780-95 for the birth of George Baikie, but this was not found to have been recorded there. The old parochial registers of the neighbouring parishes of Bower, Canisbay, Latheron and Watten were then searched from 1780-95, for his birth, which was found to have been recorded in Canisbay as follows...
 - ⇒ George son to George Baikie and Margaret Sutherland in West Mey born June 18th baptised 25th 1787.
 - ⇒ Other children found recorded to the above couple were...

James	born 19th	baptised 27:09:1767
Janet	born 18th	baptised 25:05:1771(died young?...another Janet born 1780)
Margaret	born 20th Apr.	baptised 04:05:1776
Catharine	born 22nd	baptised 24:10:1777...??
John	born 29th Oct	baptised 07:11:1778 (died young?...another John born 1793)
**Janet	born 02/ 01/1780 ??	
Benjamin	born 21st	baptised 24:11:1781
**Magnus	born 15th	baptised 21:12:1785...??
**John	born 15th	baptised 29:09:1793....??"

 (** See IGI records over page)

- "The marriage of George Baikie, senior, was then found to have been recorded thusJanuary 27th 1765 George Baiky and Margaret Sutherland in Mey were matrimonially contracted and married Feb 25th."
- "The records for Canisbay are unfortunately blank from 1722-47, the period during which George Baikie,junior would most probably be born. They were, however, searched from 1747-50, and the following entry found...
 - ⇒ George son to Walter Baikie and Katherine Dunnet in Mey born September 11th and baptised 1750."
 - ⇒ Two other children were recorded to this couple....Katharine born 2nd, baptised 09:12:1759 & Mary born 17th, baptised 23/08/1762 ."

ANCESTORS - BAIKIE

Helen's G. Grandparents - **GEORGE & MARGARET BAIKIE**

IGI Information...

● **Patron Submissions in IGI :-**

Name	Birth	Baptism	Batch No.	Patron
George Baikie married Margaret Sutherland			7104027	Larson
Baky,Elspe	18 Feb 1766	27 Feb 1766	7103901	Larson
Baky,James	19 Sep 1767	27 Sep 1767	7103901	Larson
Baiky,Margaret		10 Sep 1769	7103901	Larson
Baiky,Janet		25 May 1771	7103901	Larson
Baikie,Charlotte(mother=Janet)		13 Sep 1773	7112024	
Baiky,Margaret	20 Apr 1776	04 May 1776	7118225	Mackay
		04 May 1777	7104027	Larson
Baiky,John		07 Nov 1778	7104027	Larson
Baikie,Benjamin	21 Nov 1781	Nov 1781	7104027	Larson
Baikie,George		25 Jun 1787	7104027	Larson

● **From the IGI itself :-**

*There is a **George Baikie married to Margaret Baikie** at Canisbay 6/11/1776,children :-

Catherine	24:10:1777
**Janet	02:01:1780
**Magnus	15:12:1785
Elizabeth	06:12:1789
**John	15:09:1793

Also with this family, no support for the naming pattern....but **this could be the George born to Walter & Catherine.**

*Also there is a Harrie Baikie married to Christine Tennent with children all born at Canisbay...

Margaret	1710
George	09:11:1712
Hugh	22:01:1715

Naming Pattern...

It is a little surprising that none of George and Margaret's children were named Walter or Catherine. while his own son George was the fourth male when third place would have been expected, and Elspet, James and Margaret "don't fit". So the evidence regarding George's use of the naming pattern is ambiguous.

No evidence has been presented regarding George or Walter's occupation in their youth. A spell of service with the **Hudson Bay Company** is a possibility. It was a major employer of Orcadians in the 18th century with tours of duty in Hudson's Bay lasting 6 to 8 years. In 1800, some 80% of Hudson Bay employees in North America were Orcadians. The Hudson Bay Company or "The Bay" as it is known in Canada is the world's oldest company with a public share capital having been founded in 1670.

However the key piece of evidence is still the "scrap of paper with a list of the Baikie mothers" which Jennifer Stern of Zimbabwe has in her possession amongst her family papers showing...

“Henrietta Wares

Isobel Levoch

Margaret Sutherland

Katherine Dunnet”

ANCESTORS - BAIKIE

Helen's G. Grandparents - **GEORGE & MARGARET BAIKIE**

So, the following is a possible sequence for Walter & George / George & Margaret...

1713	Walter baptised.	Walter 0 yrs old.
1739	George born at Mey.	Walter 26 yrs old.
1749	George's parents,Walter & Catharine Dunnett married.	Walter 36 / George 10yrs old.
1750	George baptised (10-11 yrs old).	Walter 37 yrs old.
1759	George 's sister, Katherine baptised.	Walter 46 yrs old.
1762	George 's sister, Mary baptised.	Walter 49 yrs old.
1765	George, 26 yrs. old marries Margaret Sutherland	Walter 52 yrs old.
1766	George a farmer at Mey	
	1766 Elspet born	
	1767 James born....marries Esther Johnston.	
	1769 Margaret born.....dies pre 1776	
	1771 Janet born	
	1773 (?) Charlotte born	
	1776 Margaret born	
	1777 John born	
	1781 Benjamin bornmarries Helen Barneston	
	1787 George born.....marries Isobel Levock.	
1802	George, 63 yrs old, buried in Canisbay, Caithness....see the photo under Helen's parents, James and Catherine.....George's (and perhaps Margaret) grave next to his grandson ?	

GEORGE & MARGARET BAIKIE - Their Family CHRONOLOGY

<u>CODE</u>	<u>WHO</u>	<u>EVENT</u>	<u>WHEN</u>	<u>WHERE / COMMENT / SOURCE</u>
B.-3.1	BAIKIE,Elspe(a)t (BAKY)	<u>Born</u> <u>Christen.</u>	18/02/1766 27/02/1766	Canisbay,Caithness,Scotland..... <i>Pat. Sub. IGI 7103901-Larson</i> Canisbay,Caithness,Scotland..... <i>Pat. Sub. IGI 7103901-Larson</i>
B.-3.2	BAIKIE,James (BAKY)	<u>Born</u> <u>Christen.</u>	19/09/1767 27/09/1767	Canisbay,Caithness,Scotland..... <i>Pat. Sub. IGI 7103901-Larson</i> Canisbay,Caithness,Scotland..... <i>Scots Ancestry Research Society</i>
		<u>Married</u> <u>Died</u>	Not Known Circ.1841	<u>Esther JOHNSTON</u> <i>D. Armstrong</i> <i>D. Armstrong</i>
B.-3.3	BAIKIE,Margaret (BAIKY)	<u>Christen.</u> <u>Died</u>	27/02/1766 Pre 1776	Canisbay,Caithness,Scotland..... <i>Pat. Sub. IGI 7103901-Larson</i> <i>2nd Margaret born</i>
B.-3.4	BAIKIE,Janet (BAKY)	<u>Born</u> <u>Christen.</u> <u>Residence</u>	18/04/1771 25/05/1771	Canisbay,Caithness,Scotland..... <i>Scots Ancestry Research Society</i> Canisbay,Caithness,Scotland..... <i>Pat. Sub. IGI 7103901-Larson</i> 79, "Pauper", Living with brother Benjamin, Mey..... <i>1851 Census</i>
B.-3.5(?)	BAIKIE,Charlotte (mother =Janet??)	<u>Christen.</u>	13/09/1773	Canisbay,Caithness,Scotland..... <i>Pat. Sub. IGI 7112024</i>
B.-3.6(?)	BAIKIE,Margaret (BAIKY)	<u>Born</u> <u>Christen.</u>	20/04/1776 04/05/1776	Canisbay,Caithness,Scotland..... <i>Pat. Sub. IGI 7103901-Mackay</i> Canisbay,Caithness,Scotland..... <i>Scots Ancestry Research Society</i>
B.-3.7(?)	BAIKIE,John (BAIKY)	<u>Born</u> <u>Christen.</u>	29/10/1778 07/11/1778	Canisbay,Caithness,Scotland..... <i>Scots Ancestry Research Society</i> Canisbay,Caithness,Scotland..... <i>Pat. Sub. IGI 7104027-Larson</i>
B.-3.8(?) (B.-2.0)	BAIKIE, Benjamin	<u>Born</u> <u>Christen.</u> <u>Married</u> <u>Died</u>	21/11/1781 24/11/1781 1823 Pre 1851	Canisbay,Caithness,Scotland..... <i>Scots Ancestry Research Society</i> Canisbay,Caithness,Scotland..... <i>Pat. Sub. IGI 7104027-Larson</i> <u>Helen BARNESTON</u> <i>D. Armstrong</i>
B.-3.9(?)	BAIKIE, George	<u>Born</u> <u>Christen.</u> <u>Married</u>	18/06/1787 25/06/1787 12/12/1812	West Mey, Canisbay, Caithness, Scotland..... <i>Scots Ancestry Research Society</i> Canisbay,Caithness,Scotland..... <i>Pat. Sub. IGI 7104027-Larson</i> <u>Isobel LEVOCK</u> , Wick, Scotland..... <i>D. Armstrong</i>

ANCESTORS - BAIKIE

Helen's Grandparents (B.-2.)

BENJAMIN BAIKIE (Circ. 1781 - post 1861) & HELEN BARNESTON(1789 - post 1861)

CHRONOLOGY

<u>CODE</u>	<u>WHO</u>	<u>EVENT</u>	<u>WHEN</u>	<u>WHERE/COMMENT / SOURCE</u>
B-2.	BAIKIE, Benjamin	<u>Born</u>	21/11/1781	Canisbay, Caithness, Scotland...../GI
		<u>Married</u>	Not Known	(A widower when married ? - A Benjamin Baikie married Margaret Baikie in 1817)...../GI
		<u>Occupation</u>		Crofter / Farmer, 12 acres.....Census
		<u>Residence(s)</u>		Mey, Canisbay, Scotland.....Census
		<u>Died</u>	post 1861Census
		<u>Buried</u>	Not Known	
	<u>BARNESTON,</u>	<u>Christened</u>	12/07/1789/GI
	<u>Helen</u>	<u>Occupation</u>	Probably Home Duties	
		<u>Died</u>	post 1861Census
		<u>Buried</u>	Not Known	

So, the following is the likely sequence for Benjamin & Helen...

- 1781 Benjamin born at Mey Canisbay
- 1789 Helen born
- 1823 Benjamin and Helen marry
 - 1824 George born...Farmer and Master mariner....married Charlotte Sutherland at Canisbay in 1852. Dies between 1881 & 1908.
 - 1825 **James born**..married Catherine Calder.....see next story
 - 1828 Magnus born...probably did not marry.....living with parents in 1861. ..the Family Bible still in existence (who with ?). Died in 1911.
 - 1828 Benjamin born...twin brother....married Christiana Geddes in 1854 at Canisbay. Was a teacher at Freswick.
 - 1831 Helen born.....probably did not marry.....living with parents in 1861.
- 1851 Benjamin, 69, a farmer at Mey of 12 acres. Living at home were his wife Helen 67(?) and..
 - Son, James 25 - fisherman.
 - Son, Magnus 20.
 - Daughter, Helen 20.
 - Sister, Janet 79 - pauper.
- 1855 "Farm in Mey owned by the Earl of Caithness - Tenant, Benjamin Baikie - Rent valued at 10 pounds" ... *Valuation Rolls, Caithness; VR94/1 - 1855 to 1856, Canisbay Folio, No. 52*
- 1861 Benjamin, 79, a crofter at Mey of 13 acres. Living at home were his wife Helen 71, and Son Magnus 32, Daughter Helen 30.

BENJAMIN & HELEN BAIKIE - Their Family

CHRONOLOGY

<u>CODE</u>	<u>WHO</u>	<u>EVENT</u>	<u>WHEN</u>	<u>WHERE / COMMENT / SOURCE</u>
B.-2.1	BAIKIE, George	<u>Born</u>	12/02/1824	Canisbay, Caithness, Scotland...../GI
		<u>Married</u>	30/01/1852	Charlotte SUTHERLAND, Canisbay...../GI
		<u>Occupation</u>		Master mariner, farmer.....Census
		<u>Died</u>	1881-1908	
		<u>Buried</u>	Not Known	
B.-2.2	BAIKIE, James	<u>Born</u>	29/12/1825	Canisbay, Caithness, Scotland...../GI
(B.-1.0)		<u>Married</u>	24/03/1854	Catherine CALDER, Canisbay...../GI
		<u>Occupation</u>		Fisherman, Farmer.....Census
		<u>Died</u>	20/10/1912	Canisbay
		<u>Buried</u>	??/10/1912	Canisbay (No.50).....Family Bible
B.-2.3	BAIKIE, Magnus	<u>Born</u>	23/11/1828	Canisbay, Caithness, Scotland...../GI
		<u>Residence</u>		1861=32 ,unmarried living with parentsCensus
		<u>Died</u>	14/02/1911	
		<u>Buried</u>	??/02/1911	
				(Wrote family details in the Family Bible ??)
B.-2.4	BAIKIE, Benjamin	<u>Born</u>	23/11/1828	Canisbay, Caithness, Scotland...../GI
		<u>Married</u>	21/04/1854	Christian GEDDES, Canisbay...../GI
		<u>Occupation</u>		Teacher, Freswick.....Census
		<u>Died</u>	Not Known	Perhaaps Canisbay
		<u>Buried</u>	Not Known	
B.-2.5	BAIKIE, Helen	<u>Born</u>	11/01/1831	Canisbay, Caithness, Scotland...../GI
		<u>Residence</u>		1861=30, unmarried living with parentsCensus
		<u>Died</u>	Not Known	
		<u>Buried</u>	??/02/1911	??

OUR BAIKIE ANCESTORS

Helen's Parents (B.-1) **JAMES BAIKIE (1825 - 1912)** **& CATHERINE CALDER (1831 - 1921)**

CHRONOLOGY

<u>CODE</u>	<u>WHO</u>	<u>EVENT</u>	<u>WHEN</u>	<u>WHERE/COMMENT / SOURCE</u>
B-1.	BAIKIE, James	<u>Born</u>	29/12/1825	Canisbay, Caithness, Scotland..... <i>IGI</i>
		<u>Married</u>	24/03/1854	Dunnet, Canisbay, Caithness..... <i>IGI</i>
		<u>Occupation</u>		Fisherman / Crofter / Farmer..... <i>Census</i>
		<u>Residence(s)</u>		West Mey, Canisbay, Scotland.... <i>Census</i>
		<u>Died</u>	0/10/1912	88 yrs old, Canisbay, Caithness, Scotland..... <i>IGI</i>
		<u>Buried</u>	?/10/1912	Canisbay Churchyard (No.50)..... <i>Family Bible / MI</i>
	<u>CALDER,</u>	<u>Born</u>	1831	Dunnet, Canisbay, Caithness..... <i>Census</i>
	<u>Catherine</u>	<u>Occupation</u>		Home Duties
		<u>Died</u>	31/07/1921	90 yrs old, Field of Harrow, Mey, Cathness..... <i>Newspaper</i>
		<u>Buried</u>	?/08/1921	Canisbay Churchyard (No.50)..... <i>MI</i>

So, the following is the sequence for James and Catherine...

- 1825 **James born at Mey Canisbay.**
- 1831 **Catherine born at Dunnet.**
- 1854 **James and Catherine marry at Dunnet...all children born at West Mey.**
 - 1855 Jane (Jeannie) born...married Tom Swanson.
 - 1856 Benjamin born...seaman....a very significant role in our family history....see Donald's story.....died at sea 1877 on the ship Southern Cross in the Bay of Biscay.
 - 1858 **Helen born.....see main story.**
 - 1860 Georgina Calder born.....married John Leylend.
 - 1862 Catherine born.....married Captain Calder.
 - 1864 Jemima born.....married Henry (Harry) Gunn...not related.
 - 1866 Isabella born.....married John Sinclair....died in 1929.
 - 1868 John Calder born...died in 1885.
 - 1870 Magnus born.....married Jane Geddes.
 - 1872 George born....married Georgina Wallace at Skarfskerry Dunnet in 1898...was a farmer and joiner...became mentally ill in late middle age..institutionalised ...died in 1939.
- 1861 **James, 35, fisherman at Mey .** Living at home were his wife Catherine 31, and...
 - Daughter, Jane 6.
 - Son, Benjamin 4
 - Daughter, Helen 2.**
 - Daughter, Georgina 6m.
- 1871 **James, 45, fisherman / crofter at Mey .** Living at home were his wife Catherine 39 and...
 - Daughter, Jane, general servant 16.
 - Son Benjamin, scholar 14.
 - Daughter, Helen, scholar 12.**
 - Daughter, Georgina, scholar 10.
 - Daughter, Catherine, scholar 8.
 - Daughter, Jemima, scholar 6.
 - Daughter, Isabella, 4.
 - Son John C., 2.
 - Son, Magnus 9m.
- 1912 **James 86 year old, dies** and is **buried at Canisbay.**
- 1921 **Catherine 90 years old, dies** at "Field of Harrow", West Mey = probably Helen Baikie's birth place. "Field of Harrow" would then have been re-named "Rose Cottage". Catherine also **buried at Canisbay.**

ANCESTORS - BAIKIE

Helen's Parents - JAMES & CATHERINE BAIKIE

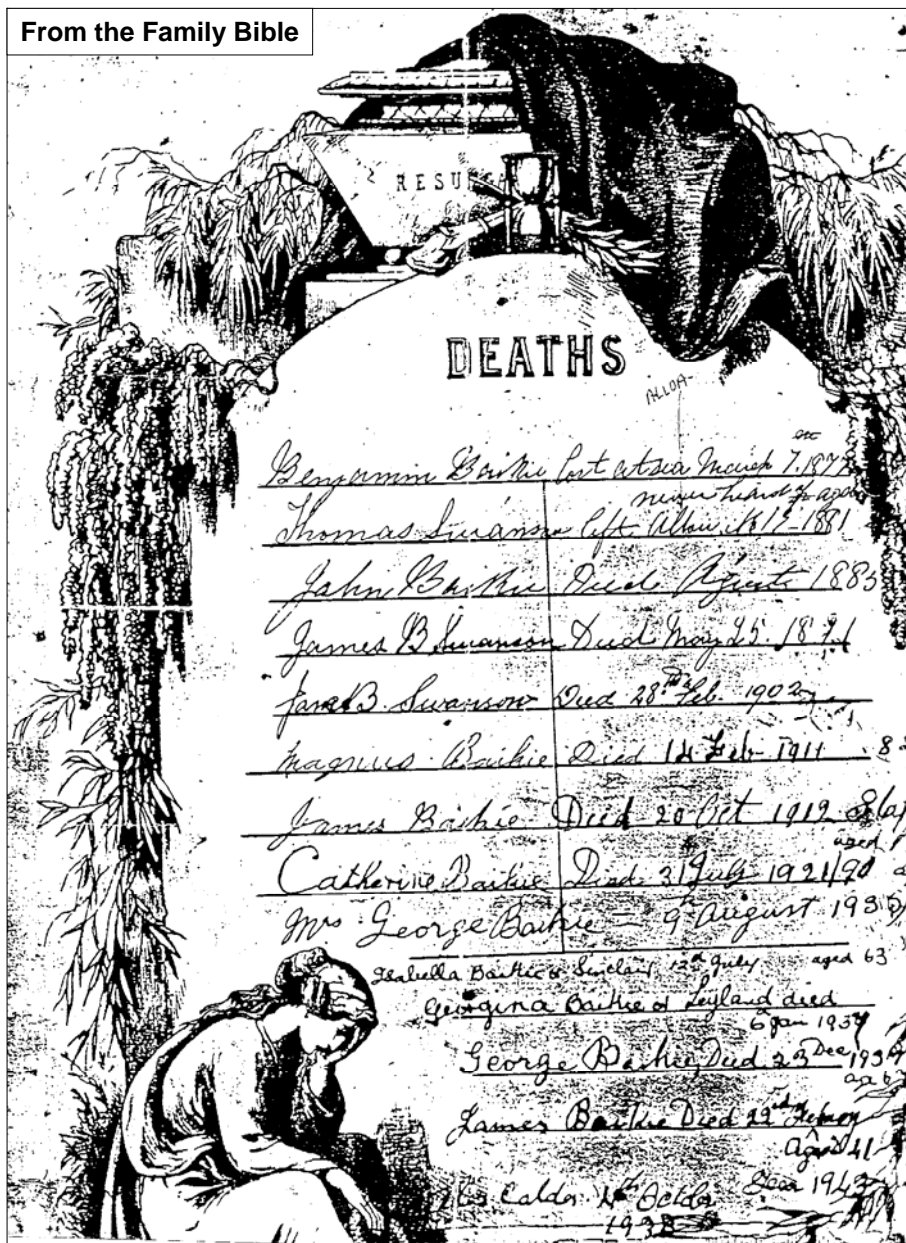

Extracts of the deaths of the family of James & Catherine from the Family Bible (Now held by Mac Waters, grandson of Magnus Baikie)

*(Child 2)	"Benjamin Baikie	Lost at sea March 7th 1877"
*(Husband of child 1)	"Thomas Swanson	Left Alloa, never heard of again 1881"
*(Child 8)	"John Baikie	Died August 1885"
*(Son of child 1)	"James B. Swanson	Died May 25th 1891"
*(Child 1)	"Jane B. Swanson	Died 28th Feb. 1902"
*(Younger brother of James)	"Magnus Baikie	Died 14th Feb. 1911, aged 82"
*(James)	"James Baikie	Died 20th Oct. 1912"
*(Catherine)	"Catherine Baikie	Died 31st July 1921, aged 90"
*(Wife of child 10)	"Mrs George Baikie	9th August 1935"
*(Child 7)	"Isabella Baikie Sinclair	12th July, aged 63"
*(Child 4)	"Georgina Baikie Leyland	Died 6th Jan. 1937"
*(Child 10)	"George Baikie	Died 23rd Dec. 1939, aged 67"
*(Son of child 9)	"James Baikie	Died 22nd Feb 1943, aged 41"
*(Husband of child 5)	"Alex Calder	4th Oct. 1938?"

ANCESTORS - BAIKIE

Helen's Parents - JAMES & CATHERINE BAIKIE

Marg Threadgold had in her memorabilia a piece of paper....

"A letter written in 1908 by Captain Calder about Grandfather Baikie....

Grandfather he is really a wonderful old man - I think about 82 years of age & the picture of good health - red cheeks and strong body, getting rather stiff, but going down the hill, manfully, like a strong ripening stalk of corn."

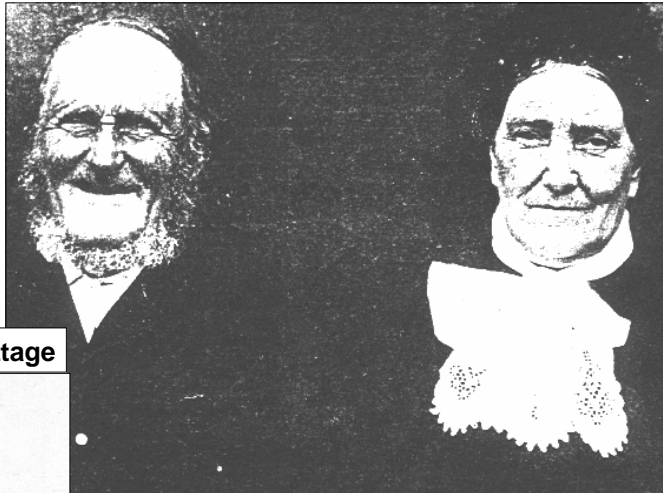

James & Catherine Baikie - Their Home - Rose Cottage

On back of photo from Helen Millar = "The house Grandma was born in"



See "The Extended Family - Child 10 - George & Georgina BAIKIE"

JAMES & CATHERINE BAIKIE - Their Family

CHRONOLOGY

<u>CODE</u>	<u>WHO</u>	<u>EVENT</u>	<u>WHEN</u>	<u>WHERE / COMMENT / SOURCE</u>
B.-1.1	BAIKIE, Jane (Jeannie)	<u>Born</u>	05/03/1855	Mey, Canisbay, Caithness, Scotland
		<u>Married</u>	07/02/1879	Tom SWANSON, (Sea Captain, 1848-1881) West Mey, Canisbay
		<u>Occupation</u>		Dressmaker
		<u>Died</u>	28/02/1902	Gardner St., Partick, Glasgow
		<u>Buried</u>	1902	Dunbarton, near Glasgow
B.-1.2	BAIKIE, Benjamin	<u>Born</u>	19/10/1856	West Mey, Canisbay, Caithness, Scotland
		<u>Occupation</u>		Seaman
		<u>Died</u>	07/03/1877	Drowned, Bay of Biscay from ship, "Southern Cross"
		<u>Buried</u>	07/03/1877	Bay of Biscay.
B.-1.3	BAIKIE, Helen (B/G.0.0)	<u>Born</u>	30/12/1858	Mill of Mey, Skarfskerry, Canisbay, Caithness, Scotland
		<u>Married</u>	25/12/1882	Donald GUNN , Manse, Port Adelaide, Adelaide, South Australia
		<u>Occupation</u>		Home Duties
		<u>Died</u>	04/07/1945	Largs Bay, Adelaide, South Australia
		<u>Buried</u>	??/07/1945	Murray Bridge, South Australia
B.-1.4	BAIKIE, Georgina Calder	<u>Born</u>	05/11/1860	West Mey, Canisbay, Caithness, Scotland
		<u>Married</u>	10/04/1883	John LEYLAND ,
		<u>Died</u>	06/01/1937	Rockferry, Birkenhead, England
		<u>Buried</u>	??/10/1937	
B.-1.5	BAIKIE, Catherine	<u>Born</u>	04/07/1862	West Mey, Canisbay, Caithness, Scotland
		<u>Married</u>	Not Known	Captain Alexander CALDER
		<u>Died</u>	19/12/1925	Clayhusbandry, Caithness
		<u>Buried</u>	??/12/1925	Dunnett Cemetery
B.-1.6	BAIKIE, Jemima	<u>Born</u>	10/04/1864	West Mey, Canisbay, Caithness, Scotland
		<u>Married</u>	Not Known	Henry (Harry) GUNN
		<u>Died</u>	Not Known	
		<u>Buried</u>	Not Known	
B.-1.7	BAIKIE, Isabella	<u>Born</u>	04/04/1866	West Mey, Canisbay, Caithness, Scotland
		<u>Married</u>	Not Known	John SINCLAIR
		<u>Died</u>	12/07/1929	Aged 63, Aultbea, South St., Milnathort, Scotland
		<u>Buried</u>	??/07/1929	
B.-1.8	BAIKIE, John Calder	<u>Born</u>	30/06/1868	West Mey, Canisbay, Caithness, Scotland
		<u>Died</u>	17/10/1885	
		<u>Buried</u>	??/10/1885	Canisbay Churchyard (No.50)
B.-1.9	BAIKIE, Magnus	<u>Born</u>	28/06/1870	West Mey, Canisbay, Caithness, Scotland
		<u>Married</u>	18/11/1898	Jane GEDDES
		<u>Died</u>	13/09/1955	West Mey, Canisbay, Caithness, Scotland
		<u>Buried</u>	??/09/1955	Canisbay Cemetery
B.-1.10	BAIKIE, George	<u>Born</u>	20/11/1872	West Mey, Canisbay, Caithness, Scotland
		<u>Married</u>	01/07/1898	Georgina WALLACE
		<u>Died</u>	23/12/1939	

ANCESTORS - BAIKIE

Helen's Parents - JAMES & CATHERINE BAIKIE

Both James and Catherine are buried in the Canisbay Churchyard.....the tall monument reads :-

- "In loving memory of **James Baikie** died at West Mey 20 Oct. 1912 aged 86 years"
- "Also his sons.. **Benjamin** officer on ship "Southern Cross" lost at sea 7 March 1877 aged 20 years. **John** died 17 Oct. 1885 aged 17 years"
- "**Catherine Calder** beloved wife of James Baikie died at West Mey 30 July aged 90 years"

The stone at the left is broken and only the top part remains...it reads "A memorial over the dust of **George Baikie** farmer in Mey who died March 9 1802" (died 12/03/1802 - James' grandfather who married Margaret Sutherland)

Monument No. 50, Canisbay Churchyard
James & Catherine BAIKIE



Catherine's death was reported in John O'Groats Journal Fri August 12th 1921. "MRS BAIKIE, MEY"

Her Death Notice :- "**Baikie - At Field of Harrow, Mey, on 31st July 1921, Catherine Calder, wife of the late James Baikie aged 90 years - dearly loved and sadly missed (Australian and American papers please copy)**".

James BAIKIE - Funeral Card

In Loving Memory
OF
JAMES BAIKIE,
The Beloved Husband of Catherine Baikie,
Who fell asleep in Jesus on 20th October, 1912,
AGED 86 YEARS.
INTERRED IN CANISBAY CHURCHYARD.

This loving flower the Gardener plucked,
This garden He hath pruned;
But bear in mind 'tis all through love,
And love can heal the wounds.
Weep not, dear friends, his soul has left
This earthly house of clay,
And God it safely has secured
Until the judgment day.

"A much esteemed member of an honourable and respected family has passed from our midst in the person of Mrs James Baikie, Field of Harrow, Mey. Mrs Baikie's illness confined her to bed for a considerable time, and her period of suffering was one of pious resignation to the Supreme Will, so that her passage was calm and hopeful. Her genealogy embraced members of remarkable longevity, herself being a nonagenarian. A benevolent and amiable neighbour, a devout Christian, and an affectionate and wise spouse and mother, Mrs Baikie was venerated in the district by a wide circle whose appreciation of her exemplary character was well manifested by word and deed.

Mrs Baikie's father, the late Captain John Calder, West Dunnet, experienced an eventful life. His personality and masterful grip of navigation raised him to a high station in his vocation, in which capacity he was always generously disposed to impart to rising aspirants his exceptionally comprehensive knowledge of nautical attainments within his province, with the gratifying result that not a few of those who thus enjoyed the tutoring of such a successful navigator attain distinction in their profession. The late Captain John Calder, Castletown, had this worthy progenitor as his grandfather. Mrs Baikie's father had, in addition to many other experiences, the honour of taking his share in some of the great sea fights of Nelson's record, and on occasion, while engaged in bringing a prize of war into Portsmouth Harbour, the crew of the prize-bearer, of which Captain Calder, then a young man, was a member, were captured and consequently the future captain was interned in France for seven years. Another brother, Captain George had also a name of honour and distinction but which was cut off in the prime of life by a lamentable boating accident in Dunnet Bay. Of a family of ten, Mrs Baikie is survived by seven, who mourn the loss of a kind and loving mother. Mrs Baikie was predeceased by her husband a few years ago."